

# WIRELESS WORLD

MONTHLY 3<sup>D</sup>

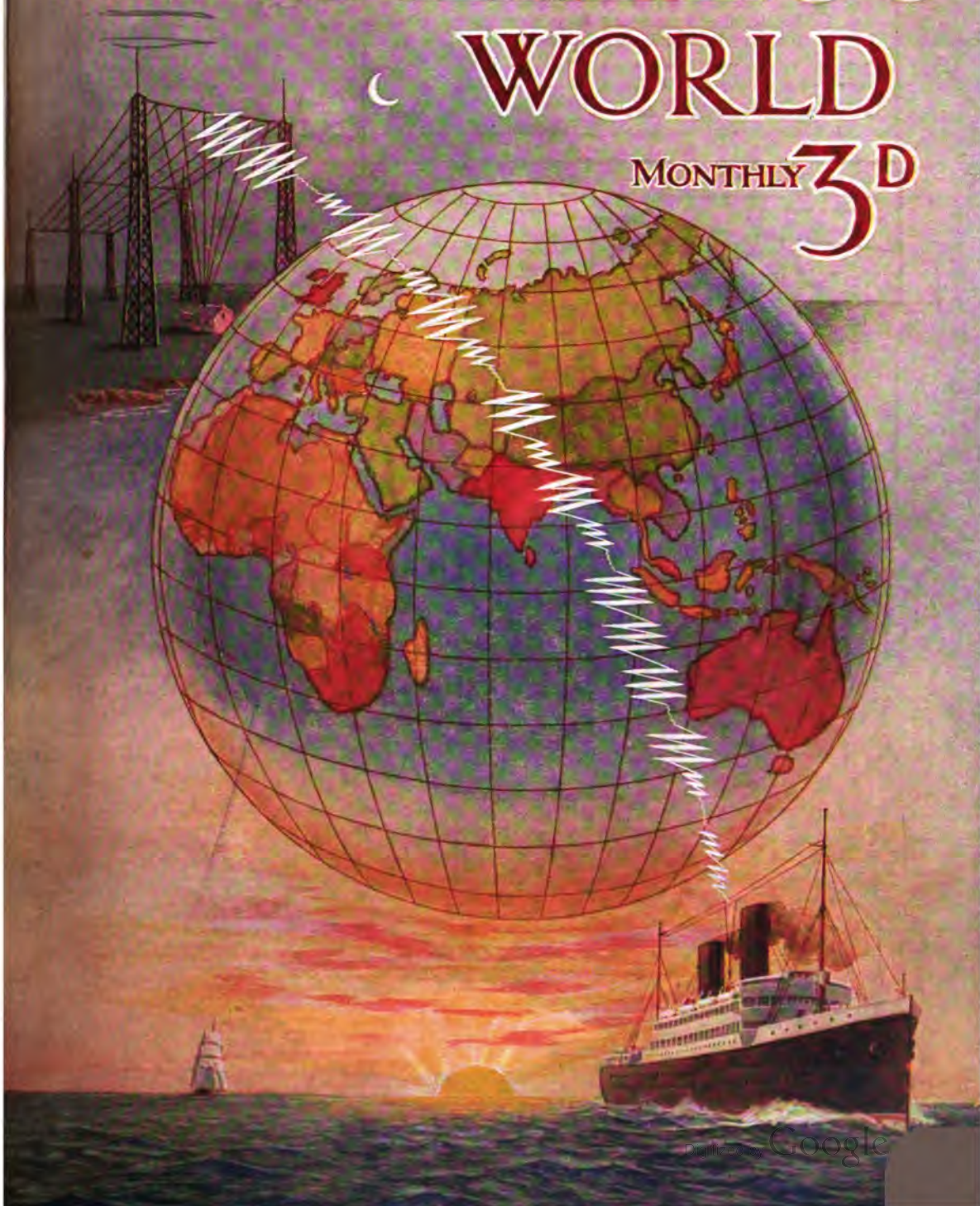



# SULLIVAN INSTRUMENTS

Sullivan "Universal" Galvanometers and Shunts for Land and Sea Use.

SULLIVAN TELEPHONE RECEIVERS.

Fast Speed Wheatstone Automatic Transmitters and Receivers, guaranteed at 400 words per minute, and Wheatstone Apparatus generally. Precision and Standard Measuring Equipments for D.C. and A.C. (high frequency) determinations, Condensers of Low Power Factor, etc.

**H. W. SULLIVAN** WINCHESTER HOUSE, LONDON, E.C., ENGLAND.

Works: LIVERPOOL HOUSE, MIDDLESEX ST., LONDON, E.C.

Telegrams: "Deadbeat, London."

Telephone: (Office: 3518 London Wall.  
(Works: 3518a " " "

Silk and Cotton Covered H.C. Copper Wire, Resistance Wires, Fuse Wire, Binding Wires, Charcoal Iron Core Wire, Asbestos Covered Wire

**P. ORMISTON & SONS,** 79 CLERKENWELL ROAD  
LONDON, E.C.  
Established 1793. 13259 Central.  
"Ormiston, London." Braided and Twisted Wires, Bare Copper Strand & Flexibles of any Construction, Wire Ropes & Cords, down to the finest sizes, in Galvanized Steel, Phosphor Bronze etc.

# NORMAN, SMEE & DODWELL

MANUFACTURERS OF HIGH-CLASS VARNISHES for Coach Builders and Decorators, Railway Carriage and Locomotive Builders, and Ship Builders. Special Insulating Varnishes for Electrical Purposes

Offices and Factory: MILES LANE, MITCHAM, SURREY.

# Willcox's

## Undertake Supply of all Requisites

### for Engine Rooms, Power Plant, Machine Shops, etc.

We shall be pleased to supply Electrical and other Engineers with copy of our enlarged

**736 pp. CATALOGUE**

on receipt of application on business form.

*Our Specially Refined Lubricants are in use on every class of Machinery.*



SEND  
US  
YOUR  
INQUIRIES

**W. H. WILLCOX & CO., LTD.**  
32/8 SOUTHWARK STREET, LONDON, S.E.

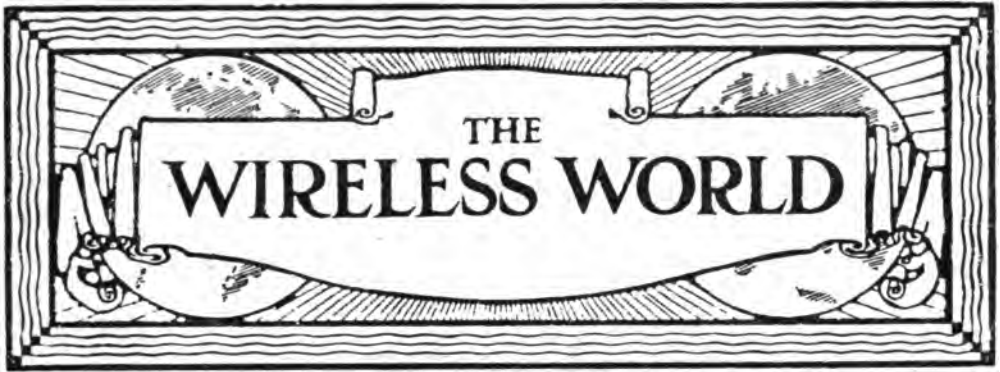

Vol. 3.—No. 25. (New Series)

April, 1915.

Subscription 5/0 per annum  
post free. Price 3d.  
Post Free 5d.

## OUR NEW VOLUME

*"We look before and after and sigh for what is not."*

**T**HE March issue finished our second volume, and to-day we start our third. The air is heavy with the thunderclouds of war, and our wireless messages are frequently "jammed" by the electrical storms of an atmosphere surcharged with the magnetic waves of military disturbances. But we take heart, and, attuning our receivers aright, we listen eagerly for the musical notes of the message we are all hoping to receive: the message of "Peace on earth; goodwill towards men."

We have had occasion frequently to remind our readers of the fact that wireless telegraphy has entered into almost every phase of the present war. Some of the points in connection therewith have appeared in our "Wireless Telegraphy in the War" pages, and we feel certain that they have proved of interest to our readers. We hope to continue these items, but we can assure our friends that when the muzzling orders, necessarily imposed under present conditions, are removed we shall have the opportunity of letting them know a great deal more than is now either desirable or possible.

Such an occasion as the present, when we thank old friends for past appreciation, and look forward to an ever-increasing circle of new ones, naturally lends itself to an admixture of apparently irreconcilable

sentiments—those of regret and hope. The regret is for our past shortcomings, the hope for the better realisation of our good intentions. Amongst the former may be reckoned our failure to hold our intended examinations promised for May. Our announcement on page 52 with regard thereto will, however, show that our failure was due to circumstances beyond our control. The examinations will certainly be held, and the time of forced abstention from experimental work would be wisely used by prospective candidates for the study of theory, and preparation for the forthcoming test.

With regard to the future, our intention is not to make any violent changes, but to improve our magazine along its well-established lines, at the same time so selecting and enhancing the quality of our matter as to deserve the increased approbation for which we hope. The success of every performance depends as much upon the audience as upon the performers. Radiation and refraction must continue constantly at work between them if the result is to show improvement. All our readers can help us by friendly criticism, and we appeal to them to favour us with that help. We have to tender our very hearty thanks to many of the most eminent men in the wireless world for assistance freely bestowed in the past, and trust that we may hope to continue to receive it in the future.



Mr. W. DUDELL, F.R.S.

# Personalities in the Wireless World

W. DUDELL, F.R.S.

ONCE only in the history of the Institution of Electrical Engineers has the much-coveted office of President been held by the same person for two consecutive years. This was in 1912-14, when Mr. Wm. Duddell, F.R.S., was unanimously invited to take and retain the lead.

Mr. Duddell, who was born in London in 1872, was originally trained as a mechanical engineer. Studying at the Central Technical College, London, under Professor Ayrton, and taking both the engineering and physics courses, he secured within three years a Whitworth Exhibition. In 1897 he obtained the Whitworth Scholarship, and following this distinction, returned to the Central College to resume the experimental work which he had previously started there. This research, based on certain phenomena associated with arc lamps, was largely inspired by Professor and Mrs. Ayrton and others who were engaged upon arc-lamp problems at the time. The particular line of investigation conducted by Mr. Duddell was, however, his own suggestion, and so excellent were the results that it was made the foundation of further highly productive research. The musical arc and the oscillograph, and other lesser-known instruments with which Mr. Duddell's name is associated were the result of this series of experiments.

The "Duddell" oscillograph is an instrument used for recording variations of electric currents and voltages when these variations are of relatively high frequency. It has proved of great value in generating stations, and is used widely by telephone companies in the investigation of sounds.

Mr. Duddell's interest in wireless transmission dates from the earliest days of his experimental work. He approached Sir John Gavey, and obtained facilities, first at Bushy Park and then across the Irish Channel, for determining the law connecting distance and

the strength of received signals. This law has since been confirmed and extended by Dr. Austin, of the Imperial Standards Committee, over distances far greater than were at first available.

In 1904 Mr. Duddell was the honorary secretary to the delegates to the International Electrical Congress at St. Louis. In 1907 he was elected President of the Röntgen Society, and in 1908, Vice-President of the Physical Society. The same year he acted as one of the secretaries to the International Conference on Electrical Units and Standards.

In 1912 the Government recognised Mr. Duddell's position in the world of wireless by appointing him a member of the technical committee instituted to consider the question of long-distance wireless telegraphy. Their faith in his ability has since been demonstrated by his appointment as Consulting Engineer to the Post Office in connection with the Imperial wireless contract. It is interesting to know that Mr. Duddell holds the opinion that wireless has a greater scope than is at present appreciated. He believes it will create for itself an entirely new and extensive traffic.

Shortly before the outbreak of war (in April last to be precise) Mr. Duddell presided in Brussels over the International Commission to aid wireless research. The programme then drafted was much hindered by subsequent events, but great as may have been the disappointment experienced by the subject of our sketch, we feel certain that it was compensated for to some extent by the prominent part he was able to play, as President of the I.E.E., in raising conjointly with two other professional institutions a corps of engineers for the Royal Naval Division.

Mr. Duddell is yet young. His brilliant career to date suggests that he may play an important part in carrying Great Britain to an unquestioned first position in electrical science.

# Resonance Phenomena in the Low Frequency Circuit

By H. E. HALLBORG.

## PART I.

IT is the purpose of this paper to outline briefly the principal low frequency circuit characteristics common to all radio transmitters using alternators and transformers for charging the condensers of the radio frequency circuit. By low frequency we mean frequencies of the order of from 60 to 500 cycles as commonly used.

The transformer is one of the important units of all radio stations, except the arc or reflector alternator type. A practical study, therefore, of the phenomena occurring in the alternator transformer circuit cannot fail to be of interest to us all. In this circuit are to be found some of the most perplexing experiences of the experimenter and of the engineer. Strangely enough, many engineers who calculate freely decrements, coupling co-efficients, and other radio frequency circuit combinations entirely overlook the fact that the low frequency circuit combinations are equally numerous and their proportioning equally important. Possibly more cases of inefficiency in wireless transmitters generally are due to improper alternator transformer circuit adjustments than to any other one cause. To sum up briefly, in the wireless circuit resonance plays the master rôle, from generator slip-rings to aerial.

In attempting this paper the writer realises that the subject has had much mathematical treatment, and that many empirical expressions covering particular phases and conditions of circuits have been derived. Unfortunately, much of this work has been presented in a way not to appeal to the average engineer. It is the writer's hope to so cover the subject that it may have more practical application than heretofore. The expressions and circuit relations given are for the most part fundamentals, or easily derived. The methods of taking these

resonance observations were devised by the writer, and the curves shown are nearly all actual graphs of measurements on circuits of various types and sizes.

Resonance readings in the alternator-transformer circuit can be obtained by several methods. Since we can readily make quantitative measurements of the variation of current and voltage, two methods immediately present themselves. The first is a method which we shall call the *primary ampère method*, and the second a method which we shall term the *secondary voltage method*.

The *primary ampère method* consists simply of plotting relations between current in the generator circuit, and step by step capacity loading in the high tension circuit. It is evident, since the circuit constants on the high and low tension sides of a transformer bear a definite relation to each other, that if the point of resonance in the primary circuit is determined the constants of the entire circuit may be closely calculated. The only equipment necessary for obtaining this data is an ammeter, a frequency meter, and a widely adjustable field rheostat. The connections for taking measurements by the *primary ampère method* are shown in Fig. 1.

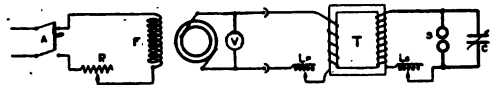

Fig. 1.

Here F represents the alternator field and R a resistance inserted in this field of such a value, determined by trial, that the primary ammeter A has less than full scale deflection when the point of resonance is reached. T represents the transformer, and  $L_p$  and  $L_s$  series connected primary and secondary inductances. These are not essen-

tial to making the measurements, but are shown to cover general conditions. C is the condenser which is to be varied in known steps.

A plot may be made between any of the variables, capacity, frequency, or ampères. The most practical method is to hold constant frequency, and to determine the relation between primary current and the capacity loading. When the exact value of C, at which maximum current obtains, is found, the value of the effective inductance of the secondary circuit is calculated by the well-known relation :

$$L_2 = \frac{10^9}{4 \pi^2 f^2 C} \text{ Henrys.}$$

C is given in MF.

This value of  $L_2$  is especially useful from the point of view of the designer, since the maximum secondary current value may be obtained from it by the relation :

$$I_2 = \frac{E}{2 \pi f L_2}$$

E is the potential applied to the condensers determined by the usual power relation.

Several curves taken by the *primary ampère method* are subsequently shown. In making this measurement with a closed core transformer error may be introduced by the low magnetic density of the iron. Ordinarily this error is not large, since high resistance silicon steel cores are now almost universally used. With open core transformers the error is negligible, since the saturation characteristic is a straight line. Slight error may also be introduced by low-saturation effect in the generator, but this has not been found to be appreciable.

The *secondary voltage method* consists of determining the relation between generator open circuit volts and the discharge voltage of a calibrated ball or sphere gap connected in parallel with the secondary condenser. The connections are somewhat similar to the primary method, and the apparatus required is no more elaborate. The connections are shown in Fig. 2.

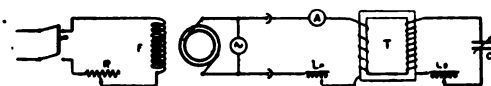

Fig. 2.

Here A represents the alternator field switch, and R an alternator field rheostat

capable of varying its excitation through a wide range. V is a voltmeter connected to read the alternator open circuit volts, and S is a calibrated discharge gap adjusted to break down at a point which will not endanger the transformer insulation. C is the capacity load as before.

The process of taking readings consists of varying C by known steps, and finding the alternator excitation which just discharges S when field switch A is closed. The point of resonance is found by noting the condenser setting C which discharges S at the lowest alternator excitation. The order of resonance effect is found by dividing the known sparking voltage of S, which remains fixed, by the voltage, V, required to discharge it. A curve may be plotted from these values showing the secondary voltage obtainable for any applied constant primary voltage as the value of C is varied. While open to criticism due to transient effect, this method gives information regarding the secondary potential under conditions that make static voltmeters unavailable. Curves taken by this method are shown below.

By reference to the vector diagrams of the ideal transformer, as given in most textbooks, we obtain three important relations between primary capacity, inductance, and resistance, and their equivalent values when transferred to the secondary of the transformer. These relations are useful enough in conjunction with transformer resonance to be here stated. They are :

$$C_1 = (\text{Ratio}^2) C_2$$

$$L_1 = (\text{Ratio}^2) L_2$$

$$R_1 = (\text{Ratio}^2) R_2$$

Given a transformer ratio of, say, 10, these expressions may be interpreted as follows : The total capacity inserted in the primary to have the equivalent effect of a capacity  $C_2$  inserted in the secondary is  $100 \times C_2$ . Similarly, an inductance  $L_1$  inserted in the primary has an equivalent effect of  $100 \times L_1$  inserted in the secondary. Likewise a resistance  $R_1$  inserted in the primary has a secondary equivalent effect of  $100 \times R_1$ . The curves presented are evidence enough of the importance of these relations in connection with low-frequency resonance. The writer has made several pre-determinations of resonance characteristics



in fair agreement with later measurement by transferring circuit constants by this means. For the predetermination of primary current the fundamental formula was used—namely :

$$I = \frac{E}{\sqrt{R^2 + \left(\omega L - \frac{1}{\omega C}\right)^2}}$$

The values of  $\omega L$  and  $\frac{1}{\omega C}$ , where  $L$  and  $C$  are the total circuit inductance and capacity respectively referred back to the primary by the relations above shown, were obtained on both sides of the resonance value and plotted. Similarly, the equivalent value of  $R$  was obtained. In finding an equivalent primary value of  $R$  in this formula a difficulty is experienced in determining a proper value of the total secondary resistance of the condenser circuit. This resistance is a function of the applied frequency, the number of condensers connected, and their manner of connection. Tests made at the Naval Radio-Telegraphic Laboratory in Washington indicate that this resistance for a single plate-glass condenser of 0.002 mf. is of the order of 50,000 ohms at 60 cycles. This figure agrees quite well with values obtained by the writer.

A most useful and practical method of getting at the low-frequency characteristics of a wireless set is by measurement of the per cent. reactance of the transformer, the alternator, and other circuit inductances. This method consists of observing the voltage drop at the terminals of each inductance in question — alternator, transformer, etc.—when rated full-load current is flowing. The per cent. reactance is the percentage voltage drop on each unit in terms of the rated voltage. For instance, if a 500-volt generator has a synchronous impedance of 10 ohms at normal frequency, and if the rated full-load current is 10 ampères, the impedance volts of the machine is  $10 \times 10$ , or 100 volts, and its per cent. reactance is 100/500, or 20 per cent. Similarly, two or more reactances connected in circuit are added arithmetically to obtain the *per cent. total circuit reactance*. This is the reactance value having direct bearing on the resonance characteristic. From it may be obtained the total primary inductance value,  $L_1$ , as well as the

total secondary inductance value,  $L_2$ , as follows :

$$L_1 = \frac{\text{per cent. total circuit reactance} \times \text{normal primary volts}}{2 \pi f \times \text{normal primary current.}}$$

$$L_2 = \frac{\text{per cent. total circuit reactance} \times \text{normal secondary volts}}{2 \pi f \times \text{normal secondary current.}}$$

Having these inductance values, the capacity required for resonance is easily computed from the formula :

$$C = \frac{10^6}{4 \pi^2 f^2 L} \text{ microfarads.}$$

The capacity value is usually fixed by considerations other than transformer resonance, and the problem is one of adjusting the circuits properly for the specified capacity values. A few experimentally determined facts tend to simplify this adjustment. Nearly all spark transmitters operate most efficiently when the natural frequency of the alternator-transformer

circuit—*i.e.*,  $F = \frac{1}{2 \pi \sqrt{LC}}$ —is lower than

the impressed circuit frequency,  $f$ , of the alternator. The exact percentage difference between  $F$  and  $f$  varies with the type of spark gap used. The writer has found that a value of inductance 30 per cent. greater than the resonating value is a proper value for synchronous rotating gap types, and for quenched gaps a value 40 per cent. in excess of the value to give transformer-alternator resonance. The natural frequency of the circuit, therefore, must be 12 per cent. to 15 per cent. lower than the impressed frequency,  $f$ . In some cases it is necessary to detune to the extent of 20 per cent. or more ; but wide detuning always results in loss of efficiency. In the case of quenched gaps the choice usually lies between a clear note with lower efficiency and a medium note with higher efficiency. The value of  $L$  for quenched spark sets, as above given as 40 per cent. over the resonance value, is a mean between the limits just mentioned.

The transformers for the American Marconi high-power stations were successfully adjusted by the methods above outlined. No condensers were required for test purposes, and the available test frequency was only 60 cycles, whereas the rated frequencies of the several equipments covered a wide



range. All of these transformers are of the closed core, oil-cooled type. The aggregate capacity of 300 kw. per station is obtained by paralleling four 75-kw. units and supplying one spare unit. The complete breakdown of the transformer equipment is thereby made quite remote.

A transformer of the closed core type, with alternate primary and secondary windings, lends itself well to wide reactance variation. The design is not unlike the tub arc lighting transformer. The difference between the two lies in the fact that the flux leakage of the tub type is a function of the load, while the leakage of the wireless transformer is fixed, and made sufficient to suppress arcing and excess wattless current upon spark discharge. With this type the required leakage is obtained by proper separation of the primary and secondary coils. The exact amount of leakage in the transformer is apportioned as controlled by the total circuit inductance found necessary, and is high or low as the condition may be.

*(Part II will be published in our May issue.)*

In the case of the transformers for the Marconi high-power stations it was necessary to adjust precisely the reactance of each unit to ensure proper division of the load when four units were operated normally in parallel. When similar adjustment of all the units for one station had been made, actual reactance readings on one unit were found to suffice, since the combined inductance value for normal operation could be obtained by dividing the single unit value by the number of units it was desired to operate in parallel. Actual measurement on four units in parallel checked this assumption exactly. The problem of reactance adjustment in a circuit consisting of alternator, several transformers in parallel, and a series of secondary loading coils is to determine the combined transformer inductance which, with the alternator and the secondary loading coils, gives a total secondary circuit inductance 30 per cent. in excess of the inductance calculated for resonance with the specified capacity.

---

## The Heavyside Layer

### *Some further Correspondence*

THE correspondence on this subject, which we summarised on pages 763-764 of our March issue, is still being continued in the *Electrician*. Dr. Eccles replies to Mr. Murdoch in the following terms:

"It is asked why layers of ionised air, if present in the atmosphere, will sometimes reflect, at other times refract, electric waves, according to theory. The answer is that it is all a matter of gradient of ionisation. If the concentration of ions increases very slowly as distance from the earth increases, then there is a gradual bending of the rays, which is called 'refraction' for short; if, on the contrary, there are no ions at low levels, and then at some high level a rapid gradient of ionic concentration, the rays travel in straight lines till they meet the sharply-marked boundary of the ionised layer, when they

experience the rather sudden downward bending which is called, for short, 'reflection.' The first phenomenon appears to occur in an atmosphere ionised by sunlight, the second at night, when the ionisation must be due to a different cause and is apparently permanent. Such evidence as geophysics afford for the existence of this permanent layer, which I have named the heavyside layer, has been collected and published by me already.

"In case an analogy may clear matters I may remind readers that the visibility of the sun or a star after it is really below the horizon is due to refraction in layers of air of varying density. On the other hand, the mirages formed by layers of air over tropical deserts are sometimes due to reflection at the sharply-marked interface between hot and cold air. Excellent examples of the refraction

tion of electric waves have been adduced by Prof. Fleming in his recent Physical Society Paper, discussing the effects of the gradual diminution of the electric inductivity of the atmosphere with increase of height.

"Mr. J. E. Taylor, in amazing sentences, speaks of enormous atmospheric conductivities being assumed in discussions of the effect of atmospheric ionisation on the propagation of electric waves. Although air may be given as great a conductivity as sea water, such an extreme degree of ionisation is not demanded in the hypotheses which I have originated. In the 'Proceedings' of the Royal Society, June 5th, 1912, I have given formulæ for calculating the ionic concentrations demanded, and there are numerical examples in plain language. For instance, it is shown that the number of ions of molecular size required for bending the trajectories of electric waves of 6,000 metres length to the curvature of the earth is about 16,000 per cubic centimetre. This involves a conductivity about a million times smaller than that of sea water."

"Mr. W. H. F. Murdoch compliments Dr. Eccles on the letter quoted above and characterises it as a very good defence of the 'Heavyside' layer. He proceeds to discuss Dr. Eccles' letter as follows: 'He admits that the layer is not ionised by sunlight at night,' and that 'it must be due to a different cause,' as I pointed out by arithmetical calculation. It seems to me it is another case of a 'generalisation killed by fact,' and I doubt whether Lord Kelvin's twenty-one coefficients (*vide* Baltimore Lectures) could possibly fit the Maxwellian equations into the 'watertight compartments' now demanded by wireless telegraphists.

"However, the first step is to get rid of superfluous assumptions of which the Heavyside layer seems one. Dr. Marchant in last week's issue postulates another set of conditions in addition to it!

"With regard to Mr. Taylor's contention I do not agree, as Dr. Eccles has proved a high conductivity unnecessary. But some people seem to imagine the earth is surrounded by a concentric sphere having the conductivity of copper!

"Neither do I think too much attention should be paid to the views of Arrhenius and Schuster as to what is occurring in the upper atmosphere—nobody knows; and it is

better to admit the fact than to pile one postulate on the top of another."

"Mr. J. E. Taylor expresses gratification at finding that Dr. Eccles supports his contention that there is no justification in fact for the assumption of a layer of heavily ionised air having a conductivity at all comparable with that of sea water. He goes on to say 'If the whole atmosphere were electrically luminous day and night, conductivity of that order might be expected.' In view of the explanation he now gives I do not see the bearing of his remark (in your issue of January 22nd) as to the possibility of rarefied air under certain conditions possessing conductivity of the order of sea water. As to my amazing 'sentences,' I must urge that we live in amazing times.

"I have not, as yet, raised Dr. Eccles' own special theory as an issue; but it does not appeal strongly to me on account of the following considerations, among others:

"1. The conductivity necessary to produce the required refraction would, apparently, have a serious attenuating effect on the waves, due to absorption. This, it seems to me, is a similar problem to that of depth of penetration of waves of high frequency currents into conducting or semi-conducting media.

"2. Dr. Eccles' theory apparently involves recourse to the reflection hypothesis for the explanation of night ranges. It would be interesting to have his calculations as to the ratio of reflected to incident wave energy at the boundary of a layer of reasonably ionised (but non-luminous) air, even assuming the most abrupt transition possible at the boundary of the layer. I imagine the ratio would be almost a negligible quantity.

"3. What justification is there in fact for the assumption of anything but a gradual transition in degree of ionisation as height above the ground is increased?"

---

## A CORRECTION

We have to call our readers' attention to the fact that in our March issue, page 784, in recording the death of General Thys, the date of his decease was printed as February 18th, instead of February 10th.

# Digest of Wireless Literature

ABSTRACTS OF IMPORTANT ORIGINAL ARTICLES DEALING  
WITH WIRELESS TELEGRAPHY AND COMMUNICATIONS READ  
BEFORE SCIENTIFIC SOCIETIES.

## RADIO FREQUENCY AMMETERS.

In the February, 1915, number of *Modern Mechanics* is an interesting article by Mr. A. S. Blatterman on the subject of Radio Frequency Ammeters.

In the article it is pointed out that successful high-frequency ammeters utilise the thermal effect of the current; the way in which the heat production is measured by expansion, calorimetric effect, resistance, or thermal E.M.F. does not affect the accuracy.

In a high-frequency circuit the current in the conductor is not constant throughout the circuit, since the electrostatic capacity between different parts of the circuit causes an appreciable part of the current to be shunted as a capacity current through the dielectric. Thus in an ammeter a capacity current will pass between the terminals to which the heating elements are connected, as a capacity current through the insulating material used, and similar currents may pass to the framework. When the active element of a hot-wire ammeter is shunted by another wire the readings of the instrument will change with the frequency. The self and mutual inductance of the parts, often supposed to be negligible, are the cause of most of the errors in commercial instruments.

Mr. Blatterman shows that for an ammeter to read correctly on all frequencies the shunt which is required when a single wire will not carry the current must always be made part of the instrument itself, and not external thereto. One method for doing so is as follows. A number of wires all of the same cross-section and resistance may be fixed to heavy terminal blocks, but only one of the wires takes part in the indications of the instrument. These wires must be fine to reduce the "skin effect" to a minimum.

A numerical example is worked out of the relative currents carried by a measuring

wire of No. 30 gauge Therlo (an alloy of copper, manganese, and aluminium) and a shunt of No. 8 copper wire.

For a wave-length of 900 metres the ratios of current  $\frac{I_m}{I_s} = .553$

for 300 metres  $\frac{I_m}{I_s} = .2695$

and for direct current  $\frac{I_m}{I_s} = .000224$

from which it follows that the correction factor for the shunt is:

2.81 for 300 metres.

4.71 " 900 "

4460 " direct current.

An ammeter constructed on this principle must therefore be calibrated on the wave-length it is to be used for, and every change in wave-length requires a fresh calibration.

The indications of the instrument can be made to depend on the actual linear expansion of the measuring wire or on the sag produced by this expansion in a wire stretched between supports.

The expansion due to changes in temperature of the atmosphere must be compensated just as in ordinary hot-wire ammeters.

## ATMOSPHERIC DISTURBANCES.

Mr. E. O. Walker writes a letter to the February 26th issue of the *Electrician*, on the subject of Radiotelegraphy and Atmospheric Disturbances, prompted by Professor Marchant's recent interesting paper fully reported in our March number, on pages 748-754. He says that "the strongest disturbances noticeable when a telephone is used as the receiver are characterised at the commencement by a sound like that of a distant waterfall, and this is followed by a succession of splutters or small explosions. The most potent effects are produced when snow is falling. Strong disturbances have been observed in a yellow fog in London; and when the air is still there is not absolute

freedom from interference. On a bright morning, when the sky is clear and the sun shining, disturbances of a similar character have been noticed from sunrise for three hours before rain fell, the wind being south-west. It would appear in this last case as if a mass of electrically-charged vapour drifted for many miles in front of the approaching rainstorm. But it is not only that a south-west wind occasions this phenomenon, but in a minor degree it is observable when the wind is coming from any other quarter. Again, when rain is actually falling the electrical discharges are present more often than not. The early morning before sunrise is a quiet time, but from sunrise to 11 o'clock at night there is little actual freedom from interference. Within the limits of observation it may perhaps be said that from 9 a.m. to 10 a.m. and 8 p.m. to 9 p.m. are the least disturbed hours of an otherwise 'splutter-full' day." He concludes his observation with the statement that, in order to rule out the class of disturbances referred to, it is necessary to provide a certain margin of power for transmission, and a certain coarseness for receipt of signals.

#### INSTITUTION OF ELECTRICAL ENGINEERS.

The following is an abstract of the discussion on the "Applications of Electrical Engineering to Warfare," which took place in the Students' Section of the Institution of Electrical Engineers on March 3rd, as announced in our last number.

Section (a), "Communications," was opened by Mr. P. R. Coursey: Communications are the nerves of an army, while rapidity is an essential element of modern warfare. Fire and flashlight signalling has long ceased to be utilised as a means of official communication, and the applications of electrical engineering have enabled great strides to be made towards the ideals of speed and secrecy. The Boer War furnishes us with the first example of the use of the electric telegraph for military purposes, although it had not then the reliability that is now regarded as essential. The heliograph was also largely used in that war and foreshadowed the uses of wireless for war purposes, especially for such a type of campaign. In the Russo-Japanese War we find the telegraph and also the telephone

fulfilling very important functions, while the same war has also a further interest as being the first time when wireless telegraphy, as we now know it, took a part in any communications. In the present war electrical means of communication are naturally being employed to an enormous extent by all the nations involved. Five main types of electrical apparatus for communication purposes are being employed by the conflicting armies: (a) wireless telegraph; (b) Wheatstone automatic telegraph; (c) Morse sounders; (d) vibrator telegraph; (e) field telephone; the last two being generally combined into one apparatus.

Mr. Coursey then continued with brief descriptions and illustrations of the most general types of military apparatus, and compared their uses and relative advantages.

Mr. Smith-Rose referred to the difficulties of reception of wireless messages on aeroplanes on account of the noise of the engine, and asked for details of means employed to minimise interference from this cause.

Mr. Emtage suggested that it might be possible to detect the approach of Zeppelins and submarines by picking up their ignition sparks by wireless receivers, and also described the pneumatic headpiece "shock-absorbers" worn by airmen, which at the same time serves to deaden the noises due to the engine and facilitated wireless reception.

Mr. Killingback asked how the wireless aerials were arranged on submarines.

Mr. Wellings referred to the possibility of the "tapping" of messages by spies, and asked for information as to which means of communication it was easiest to "tap."

Mr. Rashis enquired as to the working of the various systems employed and the differences between them.

Mr. Heslop spoke about the relative weights of different forms of masts for aerials, and the times required for erection.

The Chairman (Mr. Duddell) contrasted the modern means of communication with those employed in wars a hundred years ago and more, and referred to the old semaphores used for communications overland, and to the introduction of the electric telegraph.

Mr. Coursey replied to the various points raised in the discussion.

Section (b), "The Firing of Mines and Explosives," was opened by Mr. S. Killingback, who said that the advantages of



electrical means for firing mines may be briefly summarised as: (a) convenience; (b) greater reliability; (c) remote control; (d) simultaneous firing of several charges. Mines and explosives may be fired either by accumulators or by the portable hand operated service dynamo. The standard types of electric fuses and detonators require a current of about 0.8 amp. for fusing.

In the discussion which followed Mr. Emtage asked why platinum-iridium wires were employed in the standard service fuses, and also expressed an opinion that Tri-nitro-toluene was superseding guncotton and gunpowder in the fuses.

Mr. Heslop referred to the fact that electrical firing of mines was not employed in the Russo-Japanese War, and that the chief field for electrical firing of mines was for harbour protection, as reliable connections and cables could then be laid. The ordinary time fuses are generally satisfactory in other cases.

The Chairman (Mr. Duddell) referred to the exploder captured from the Boers (which was of German make even at that time) that was now preserved in the Institution Library.

Mr. Killingback made a short reply to the chief points raised in the discussion.

#### KEITH LECTURES.

The fourth and concluding lecture of the series of Keith Lectures, under the auspices of the Royal Scottish Society of Arts, was delivered on February 22nd in the Society's Hall, 117 George Street, Edinburgh, by Mr. J. Erskine-Murray, D.Sc., F.R.S.E., M.I.E.E. The subject of the lectures was "Electric waves and the principles of wireless telegraphy and telephony." Mr. James R. Milne, vice-president, presided over a large attendance.

Dr. Erskine-Murray, in his concluding lecture of the course, gave an explanation of the way in which signals were received, and a description of the methods of wireless telephony. In regard to the former, the lecturer remarked that as the difference between wire and wireless telegraphy consisted in the use of high frequency alternating currents in place of unidirectional currents, the reception of signals necessarily involved the conversion of these into slower electrical motions, such as might be either recorded

by some type of galvanometer or rendered audible in the telephone. In certain cases, such as the steering of torpedoes or the control of beacon lights, the motions required were even slower than those of telegraphy. In the case of the Rosenath beacon of the Northern Lights Commissioners, the resonance of two pendulums had been introduced in order that the lighting up of the beacon might depend only on the proper signals, and might not occur by accident through the arrival of an ordinary ship's message. It was shown that the discovery of the coherer by Lodge and Branly had rendered wireless telegraphy practicable owing to the fact that the high frequency current received, though of extremely short duration, left a semi-permanent record of its passage in the reduction of the resistance of the coherer, a record which lasted sufficiently long for a local battery current to actuate a recorder. The methods of action of modern detectors, including the magnetic, the crystalline, the tone wheel, and the heterodyne, were explained in detail. Descriptions were also given of the various types of relays and magnifiers which were used in conjunction with detectors for the making of permanent records of wireless signals. The lecturer then turned to the subject of wireless telephony, showing how the radiated current must in this case correspond exactly in its variations of strength to the waves of air pressure constituting the sound which it was desired to transmit. It was necessary, therefore, that the alternate current radiated must be continuous, and that the control must be a gradual one, and not merely a complete make and break as in telegraphy. To attain this a variable contact, whose resistance varied in proportion to the pressure between the electrodes, was used, such an instrument being called a microphone. It was known that the microphone might either be connected in series with the aerial wire, thus varying the actual high frequency current, and, therefore, the power radiated, or might be put in the supply circuit to the arc or in the exciting circuit of the high frequency dynamo, if one were used. Other methods suitable to short distance transmission were described, and it was mentioned that the greatest distance over which speech had so far been transmitted without wires was

between Italy and Tripoli—that was to say, about 600 miles. Experimental demonstrations showing the forms of the sound waves constituting different vowels and consonants, and a method by which the voice might be made to control the current in an arc, were given. In conclusion, the lecturer indicated various directions in which the energy of electric waves might be applied other than to the transmission of intelligence.

The Chairman, in proposing a vote of thanks at the conclusion, said the lecturer was one of the pioneers in connection with wireless telegraphy. His lectures had been not only full and comprehensive, but also authoritative, in that he had the happy art of wearing his learning lightly and of explaining the very difficult and recondite parts of the subject by means of simple and convincing experiments. (Applause). In the name of the Society, he tendered Dr. Erskine-Murray a hearty and appreciable vote of thanks for his brilliant course of lectures. (Applause.)

#### BIRMINGHAM UNIVERSITY.

Dr. Wall, a distinguished member of the professional staff at Birmingham University, lectured for nearly two hours to an interested, enthusiastic, and appreciative audience at the Technical School on Tuesday, March 9th. As a matter of fact, the Government's ban on wireless installations robbed the proceedings of some of its interest from a spectacular point of view, but what was lacking in the matter of demonstrations was compensated for in the wealth of information which the lecturer was able to impart. Mr. E. A. Allcut, M.Sc., presided, and spoke appreciatingly of Dr. Wall's kindness.

The lecturer outlined the history of signalling and incidentally referred to the use of the heliograph during the South African War; as early as the eleventh century there was a system of heliograph. He showed how electric waves were intimately connected with light. Of the complicated and advanced subject, Dr. Wall had much to say of the work of Marconi and of Sir Oliver Lodge. Of the latter's experiments in receiving apparatus he demonstrated that the message was received in the form of a musical note which was exceedingly easy to detect, and easy to tell when a signal was coming from any particular station.

The installations on board ship were described and the way in which the signal was given, by the significant "click" that a message was being sent. This development of the Marconi system was shown to be one of the most romantic incidents in modern history. The station giving communication between Clifden and the United States and the station at Poldhu in Cornwall were referred to. In 1896 Marconi patented the horizontal aerial; the importance of that was explained by the fact that messages could be sent in a given direction with greater success. The earth contact for one of the aerial wires proved to be an immense advantage in signalling over long distances, but the reason was not yet capable of explanation.

The Chairman referred to several important points in the lecture. For instance, the connection between light and the electric wave was of interest to all. The secret of cold light had not yet been penetrated. When they thought of the millions of tons of coal that were wasted in producing heat which was not wanted in connection with lighting they saw the importance of the subject. Speaking of the mechanical appliances which the lecturer had used in the demonstrations, he said that many of the experiments made in the laboratories had been laughed at by so-called practical men who had regarded them as playthings for scientists. But it seemed that a very large part of the science—the practical science—of wireless telegraphy had been built up on the use of "scientific toys."

Mr. Guest proposed the vote of thanks to Dr. Wall. He said how indebted all must be for the knowledge gained from such an interesting lecture.—Mr. Adams, seconding, said that reference had been made to the horizontal aerial.

Dr. Wall mentioned that scientific experiments had been impossible because the Government had commandeered the University installation. There was no question of getting permission; there was no apparatus to be had. Further, it was inadvisable to make experiments at this juncture. Having replied to a number of points raised, he said that it was a pleasurable duty to have done something to interest students in the wonders of wireless telegraphy.

# Trinidad Station

## *A Description and the Official Report of Successful Working.*

**T**HE Colonial Office Report No. 819 Trinidad and Tobago, which constitutes the latest report issued for these British Colonies, makes the gratifying statement that the new 5-kw Marconi Wireless Station at Port of Spain, established some little time ago, has been, since its installation, in continuous working, and "has proved to be very satisfactory." Communication has been frequently held at night up to a range of 1,500 miles, while during the day it is always possible to com-

municate with the Curacao Station, some 500 miles to the west. Another station has been erected at Toco (near Pointe Galera) on the north-east coast, which will enable



*Trinidad Aerial.*



*Aerial in course of erection.*

earlier information of the movements of shipping to be communicated to Port of Spain.

The installation possesses a guaranteed daylight range of 350 nautical miles, which is largely exceeded under favourable conditions. During the night the wave-length is 600 m. to 2,000 m., the aerial being of the standard T type. The towers are 200 feet high and 550 feet apart. The alternator for the wireless installation is driven by a direct current motor which takes its supply from a Tudor battery, this latter being charged from a dynamo driven by a Gardner oil engine. Mr. A. G. Bell, Director of Public Works at Port of Spain, superintended the erection of the towers and the wireless plant. The towers, as will be observed from our illustrations, belong to the tubular type, in which the contractors (Messrs. Stewarts & Lloyds) make a speciality. It may be interesting to note that the second tower was erected in the extraordinarily short space of two hours. One of the advantages of this design consists in its being

possible to build these tubular structures in long unsupported lengths, thus reducing to a minimum the number of parts, and simplifying the process of erection. Our second figure will show that its great strength renders possible the putting together of the structure horizontally. Subsequently it can be raised to the vertical position by means of long tubular derricks and winches. It is not usual to fit with guy ropes towers of this construction less than 200 feet high. Where this height is exceeded some slight modifications are introduced, which enable suitable arrangement to be made for this method of support. The island of Trinidad occupies a highly important position amongst the Caribbean Colonies of Great Britain, standing as it does close to the main land of Venezuela, and dominating the mouths of the great river Orinoco as well as the safest strategical entrance to the can Sea for the ships of Great Britain.

The climate is one of the most tropical of the British West India Islands. The vegetation, fertilised in highly nutritious soil, furnished with an ample supply of moisture, and growing under a hot sun, is characterised by gorgeous luxuriance. Next to Jamaica, Trinidad ranks as the largest British island in this part of the world. Its exports are already considerable, and yearly increase in volume and value; the increase, for instance, of 1913 over 1912 (the latest statistics available) amounted to £1,019,131. Port of Spain, the capital of the Island, stands on the site of an old Indian village about two miles from the mouth of the Caroni River, and contains a population of about 55,000. Our illustrations will serve to give some idea of the nature of the scenery in this favoured climate. The prints depicting the masts during erection and in their final position we owe to the courtesy of the *Electrician* and to that of Messrs. Stewarts & Lloyds.



*A Corner of the Botanical Gardens, Trinidad.*



# Proposed Wireless Control of Public Clocks

By ALFRED E. BALL.

*WE are indebted to the "Horological Journal" for the following interesting paper, written by Mr. Alfred E. Ball, which we reprint in full. The article deals with the novel suggestion of using "wireless" for regulating public clocks, and we feel sure that it will appeal to many of our readers, some of whom may have turned their own thoughts in this direction, and may like to give us their views on the subject.*

Radiographic waves have proved of great service to the science and practice of horology in the distribution of time over extensive areas, its most striking service in this direction being perhaps the exact determination of longitude of observatories and equivalent land stations.

Radiographic waves will doubtless, in course of time, be pressed into the service of the horologist in many ways, and one of the most useful forms will, in the writer's opinion, be the wireless control, or rather supervision, of public clocks. The synchronisation of public clocks is a question we have always before us. The writer proposes and advocates, as a solution of the question, a system of wireless supervision.

The scheme advocated, and which has been put to a practical test by the writer, consists briefly in fitting each of the main public clocks of a town with a small wireless transmitting set, which would be operated periodically by the clock at definite times, and the installing of an official wireless receiving station at which the various clocks would be checked daily. By means of this system each public clock would report its time-keeping, and on any clock having an error greater than a certain small pre-determined value, steps should be taken at once to have it corrected.

The working of the scheme would be as follows:—

It is assumed that it is desired to place eight of the principal clocks of a town under wireless supervision, and these clocks have been fitted with the automatic transmitting apparatus which will be hereinafter described.

At the sound of an "Attention" bell (arranged to ring shortly before 10 a.m.) the person deputed to "listen in" at the wireless receiving station, which we will assume is installed at the Town Hall, takes his place at the receiving instrument, and takes the

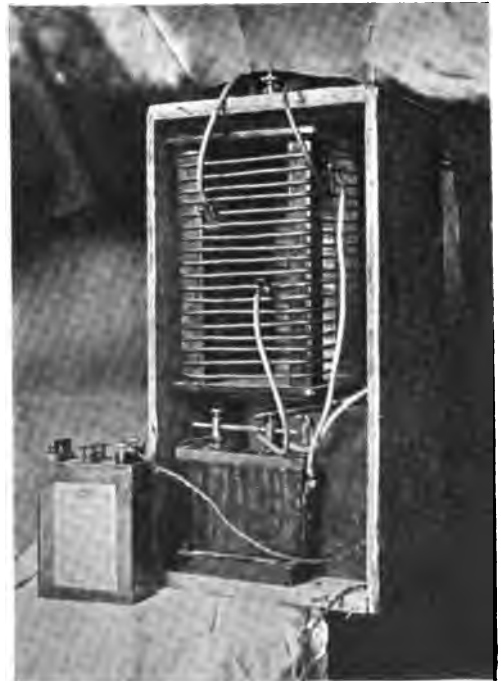

Fig. 1.

10 o'clock Paris time signal, from which he checks a standard clock, which should be provided with a seconds hand.

instrument to a position suitable for the reception of a 50 metre wave-length which would be marked on the coil, and he then

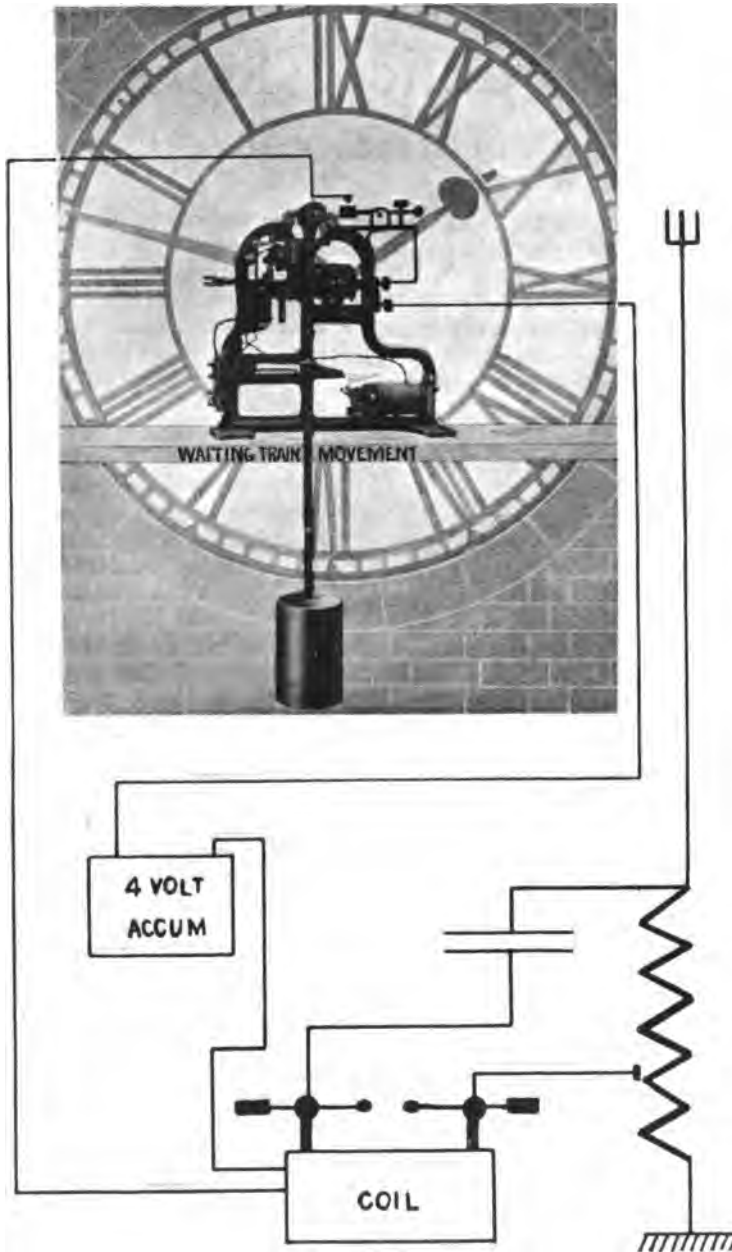

Fig. 2.

The error of the standard clock is duly noted in the "clock rate book." He then moves the tuning slides of his receiving

"listens in" for clock No. 1, which has been arranged to send its signal at 10.1 a.m. As soon as he has moved his slides to the re-

quired position, he hears clock No. 1 sending a series of short "buzzes" which continue for approximately a whole minute, and terminate precisely when No. 1 clock shows 10 hours 1 minute a.m. By keeping his eye on the seconds hand of his Standard clock while listening, he is able to note the error of clock No. 1 to a second, and this error is duly noted in the rate book in a space provided against the number of the clock.

No. 2 clock does not commence sending its signal until 10 hours 1 minute 40 seconds. The longer time has been given to clock No. 1 to give the operator ample time to tune in sharply and so get good signals. At 10 hours 2 minutes by No. 2 clock it signals its time by its last "buzz," and its error is also noted in the rate book.

No. 3 clock is next listened for, and so on, with the remaining five clocks, the entire process occupying eight minutes, or, including the taking of the Paris time-signal, eleven minutes.

Means would be provided to enable the different clocks to be identified. The intervals of 40 seconds between the signals should be sufficient to prevent overlapping, as no public clock should have such an error. The signals would be repeated by the clocks again at 11.1 a.m., so that the times may be confirmed if desired, and could be repeated again at say 3 p.m., so that supervision may be exercised twice daily.

It is usual to associate "matters wireless" with tall and unsightly aerials and with expensive instruments requiring considerable electrical power where "sending" or transmitting is concerned. The writer has proved that, for the purpose in view, the aerial may be quite unobtrusive, the apparatus simple and inexpensive and the power small.

Fig. 1 is a photograph of the transmitting apparatus employed by the writer. This is a simple affair, and is contained in a box measuring 1 ft. 8 in. by 1 ft. by 8 in., and is operated by a small 4 volt ignition accumulator which would last one month or longer with one charge.

Each turret clock to be supervised would require the following:—

(a) A transmitting apparatus as shown in Fig 1.

(b) Contacts fitted to the clock movement

to *break* contact at a certain definite pre-arranged time.

(c) An aerial which may be of an unobtrusive pattern.

(d) An "earth" connection, which may be the lightning conductor or a water pipe.

The connections of the apparatus to the contacts mentioned and to the aerial and "earth" are shown diagrammatically in Fig. 2, and, incidentally, the movement shown is an electric "waiting-train" movement, now largely used for turret clocks, and of which the writer is co-patentee with the makers—Gent & Co., Ltd., of Leicester. In this figure the aerial is represented by the usual "pitchfork-like" device, but in practice need only be a single wire. The aerial used by the writer in his experiments passed into the tower between the louvres at one end, and was secured to an insulator *inside* the tower, while at the other end an ebonite block was used, with the result that no insulators were visible to attract attention to the wire, and it passed unnoticed up to the time of its removal on the outbreak of the war. The length of the aerial was 40 ft. approximately.

The separate "buzzes" are obtained by means of a contact operated by the pendulum at each swing, and the sudden cessation of the "buzzes" is produced by a contact in series therewith, which is broken by a small lever falling off a cam fixed to, say, the centre wheel. In the case of a "waiting-train" movement, the spring which makes contact with the pendulum may be a fixed one, and may contact idly when not in operation, because the "interference" could not affect the timekeeping, but in the case of a mechanical movement this spring may be lifted out of the way by a cam when not in use, or brought into action by an electromagnet only when required.

In the case of striking turret clocks the lifting cams (or pins), or the lifting lever, could be utilised for making the necessary contacts, the last "buzz" in this instance indicating the last blow of the hour struck.

In addition to other means the clock would be recognised by its rate of striking. In checking the time of such clocks from the last blow, allowance would be made for its striking rate, thus if the intervals were 3 seconds, the clocks' actual time would be 27 seconds in advance of the last "buzz."

This method of "contacting" ensures that the striking is in order, as well as that the clock is to time, but it is obvious that not more than one—or at the most—two clocks could be checked on the "striking" at the same hour.

The amount of "latitude" which would be given to the clocks would depend somewhat on their capabilities. A town which desires to be "well-timed" should decide that should any of its supervised clocks signal an error of more than 10 seconds, its custodian should be instructed to correct it forthwith.

With regard to attention and maintenance, this would consist chiefly in exchanging the accumulator once per month for one fully charged. As, however, in the case of mechanical clocks, weekly visitations are necessary for the purpose of winding, it should be an easy matter for the winder to perform this office. The use of the mains would render this operation unnecessary, or the use of good dry cells would make this attention less frequent.

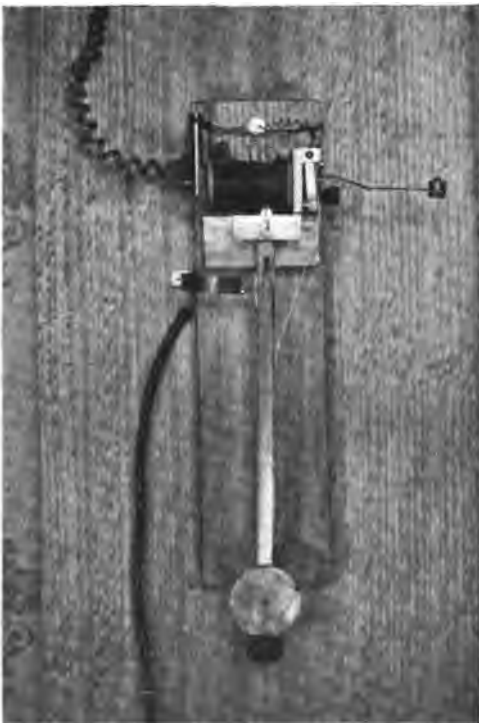

Fig. 3.

With regard to the transmitting set (shown in Fig. 1) this would be in practice completely enclosed in a dust-tight box, and as the only moving part would be the contact-breaker of the coil, little or no attention would be needed. In the event of the contact-breaker being out of adjustment this would be indicated at the receiving station. The contacts to the clockwork could be of a robust character, and could therefore be trusted to look after themselves.

Fig. 3 shows an instrument the writer has made to enable a system of impulse clocks to signal its time-keeping to the receiving station, and therefore be supervised.

This instrument consists essentially of a short and light pendulum which is arranged to operate after the manner of a slow ringing electric bell. One dry cell operates it, and its circuit is closed at pre-arranged times by contacts fitted to one of the impulse clocks in the circuit. The clock employed by the writer for the purpose was one made by his firm for ringing bells in a factory for the starting and stopping of work. The contact is closed for half a minute, and, in vibrating, the pendulum runs full tilt into contact with a spring at the end of each swing, thereby closing the circuit of the induction coil and producing a series of timed "buzzes" at the receiving station. It is obvious that by using pendulums of varying periodicities, different clock installations could be readily identified.

Fig. 4 shows diagrammatically the connections employed, which are self-explanatory. The relay shown at R is necessary to break the primary circuit of the induction coil precisely at the end of the half minute, and so terminate the "buzzes," because the pendulum, by its inertia, continues to swing and so touch the contact spring after the clock contact has broken.

Identification of individual turret clocks could be secured in many ways. First, the varying pendulum lengths could be taken advantage of when pendulum contacts are used, turret clock pendulums varying from 1 second beat up to 2 seconds or more in steps of  $\frac{1}{4}$  second, and so the frequency of the "buzzes" heard would enable the clock to be identified should it be considerably out of position on the schedule. Also, in the case of "striking" contacts, the fre-



quency of the "blows," or rather "buzzes," would be a means of identification. Coupled with the foregoing features a variation in the character of the note can be employed, and, for the sake of simplicity, this should be brought about by variations in the design of the spark-gap and contact-breaker rather than the employment of rotating gaps.

The object of advocating the employment of the short wave-length of 50 metres and small aerials is to ensure that the large commercial stations be not interfered with.

stations (which shall be nameless), has now ceased to send out time-signals.

With the scheme of wireless supervision advocated by the writer it is recommended that a Greenwich time signal, or the Post Office time signal, be installed at the official receiving station in place of, or supplementary to, a wireless time signal.

Fig. 5 shows the receiving station used by the writer.

It may be mentioned that it would not be necessary for the operator to know the

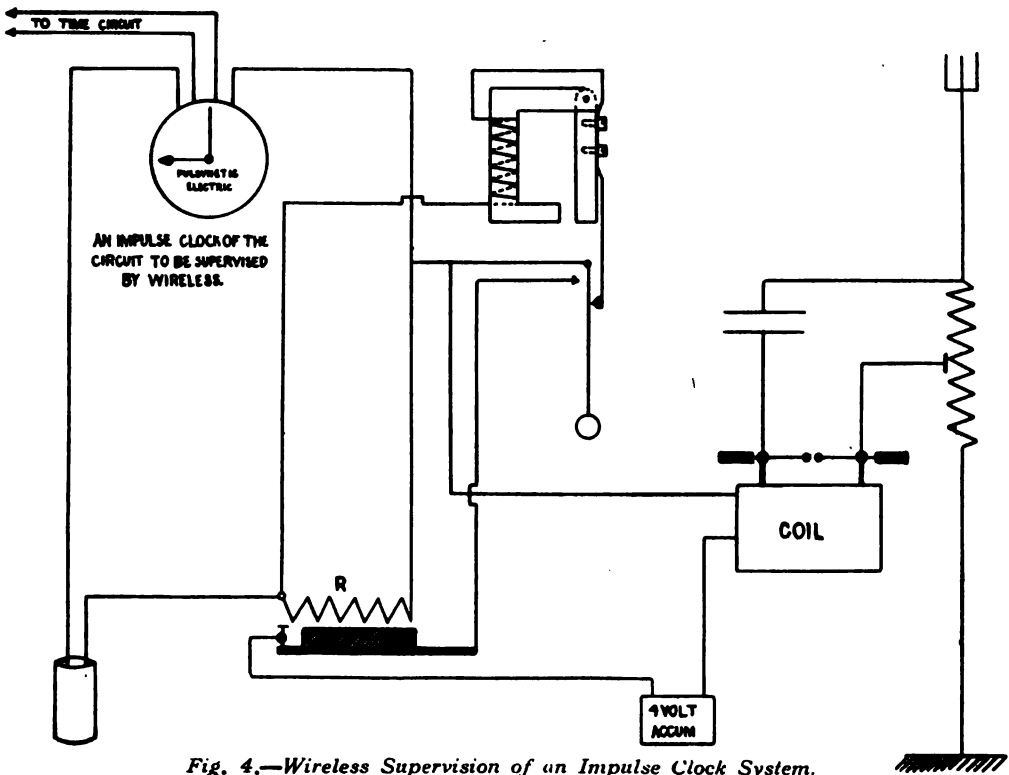

Fig. 4.—Wireless Supervision of an Impulse Clock System.

Interruption or "jamming" would be possible from local amateurs with untuned apparatus, but, as amateurs usually only display their activity at night, trouble would not be experienced on this score.

The writer's wireless apparatus (including the apparatus described and illustrated) has all been dismantled at the request of the Postmaster-General since the outbreak of the war, and it is not known to him definitely what time signals are now, or will be, sent, but he has read that one of the powerful

Morse code (to be seen on the wall in the photograph), as he would not require to use it in connection with the scheme proposed. The "spare" receiver seen enables a second person to "listen in" also.

Before wireless supervision could be adopted it would be necessary to get the permission of, and a licence from, the Postmaster-General, who would stipulate the maximum wave-length which would be permitted, and also the maximum power to be employed. The requirements of this scheme,



Fig. 5.

however, are below the limits usually stipulated.

An argument against the adoption of this scheme would be that in the event of another European war, the scheme would be put out of operation by the suspension of the licence during hostilities. The writer ventures to assert that it will be a "long, long" time before Europe will be again brought under the spell of war.

### WIRELESS IN NAVAL WARFARE.

SOME excellent articles on Wireless in connection with warfare in general have recently been appearing in *The Glasgow Herald* from the pen of Mr. Charles R. Gibson, F.R.S.E. We extract some paragraphs which have special reference to the use of radiotelegraphy by the Fleet.

"It is on sea that wireless telegraphy has an unrivalled sphere. Communication may be made between ships far distant from each other, or from ship to shore or shore to ship. Submarines and torpedo boats carry small installations capable of sending messages over a range of about 25 miles. Larger ships have more powerful apparatus, capable of sending messages to a distance of several hundred miles. And even when a ship is at a greater distance than its wireless can transmit it can send word to some ship nearer land, which ship can in turn transmit the message to land.

"Ships in the Fleet are furnished with a wireless apparatus, so that they can communicate with each other and with the shore. Each large vessel has a special duty assigned

to it; it is held responsible for keeping up communication with a shore station, with a cruiser squadron, or with a flotilla of destroyers. One ship in the Fleet must always be in touch with the Admiralty, because all foreign news concerning the enemy ships goes to the Admiralty, and thence to the Admiral of the Fleet, who directs the ships accordingly.

"When the battleships are steaming along a number of light cruisers spread out several miles in front, and each reports to a particular battleship. The cruisers are accompanied by destroyers, and there are sometimes as many as thirty ships on the look-out, each ship being equipped with wireless apparatus. When the battleships receive the messages from the advance guard they convey the intelligence to the Admiral of the Fleet on board his flagship. This retransmission over a short distance is generally done by means of a semaphore, or by Morse lamp signals. The Admiral's order to attack is sent out by wireless, and the light cruisers fall in behind the battleships.

"That the presence of wireless apparatus on board a man-of-war is considered of much value is evident from the way in which the Germans handled our old cruiser *Halcyon*, which was protecting the fishing at Lowestoft when the enemy appeared on November 3rd with the intention of raiding the British coasts. As soon as the enemy sighted the *Halcyon* they made her wireless mast their first target. They did not fire a shot at her hull until they had first destroyed her wireless rigging. But the operator had succeeded in sending out a warning of the raid, and when the enemy fled he was able to repair his wireless aerial.

"According to the home-letter of a humorous Jack Tar, the North Sea Fleet once became so impatient waiting on the German Navy to come out from their place of safety that the British Admiral sent the German Admiral a wireless message saying, 'It's a fine day for a sail, sir,' but he wouldn't come.

"The British Fleet in the North Sea is not cut off from the daily happenings in the world, for each night the Marconi station at Poldhu (Cornwall) transmits to ships at sea a summary of the day's events. Some ships of the Grand Fleet print a 'daily sheet' of such wireless news."

# The ENGINEERS Note Book



[Under this heading we propose to publish each month communications from our readers dealing with general engineering matters of various kinds in their application to wireless telegraphy, and we would welcome criticisms, remarks and questions relating to the matter published under this heading. We do not hold ourselves responsible for the opinions and statements of our contributors.]

## Four-cycle Oil Engines.

**W**E have already mentioned in former articles that constant care in the maintenance of these engines is essential to success in their use; and it may not be out of place to enter more fully into the matter of general management.

### Fuel.

The ordinary oil engine is intended for use with those grades of petroleum known as kerosine or paraffin, having a specific gravity of about 0.82 or 0.825 and a flashpoint varying from 80° to 100° (close test). The higher the specific gravity the greater will be the heat required on the burners for keeping the vaporisers at correct temperature. The oil used should not be too rich in tarry constituents. A surplus of tar in the fuel will render the lamp passages and valve stems liable to be "gummed" up much more quickly, and thus necessitate more frequent cleaning. It is hardly necessary to say that the oil should be perfectly free from all foreign matter (dirt, etc.).

### Pressure Fuel Feed.

Oil engines are often constructed to operate by either pressure or gravity fuel feed, the pressure feed giving a steady and continuous flow to the burners and feeders so long as the engine is in motion. The equipment consists of a reservoir capable of holding a small quantity of fuel, and arranged so as to prevent the liquid rising above the level of one-third of its height.

For preliminary use a filling plug is placed at the side, and a small air pump is fitted for supplying the initial pressure while heating up the engine vaporisers. Both the valve communicating with this reservoir and the fuel pump on the engine should be closed while "warming up"; but when the engine is started the valve should be immediately opened, thereby allowing a fresh charge of fuel to take the place of the supply in consumption. As the general principle of this pressure feed is that of an air chamber, the liquid will never rise above the level it attained when the pump starting working, unless the attendant allows a certain quantity of air to escape. In the event of an engine standing by with the lamps burning for some considerable time, it would be prudent to make sure that the oil is at an adequate level. This is most readily effected by slightly loosening the filling plug and allowing a minute leakage of air, watching the pressure gauge at the same time to prevent the supply falling below the requirements. As soon as oil commences to ooze from the filling plug the latter should be tightened down, as the oil has then reached its normal level, and will remain so as long as the engine is running. The fuel pump is of a capacity far in excess of that necessary for the combined service of vaporisers and burners, and to relieve this surplus an automatic by-pass valve, controlled by the air pressure acting upon a little piston, is arranged at the side. This piston valve is spring loaded; it is adjusted externally, and the pressure can be regulated to any required

degree even while the engine is running. No regulation of this should be necessary after the adjustment most suitable to local conditions and the fuel in use has been secured. Generally speaking, the engines are tested at about  $3\frac{1}{2}$  lb., but they will work at pressures varying from 2 to 4 lbs. per square inch. The instruction book will give the pressure at which the test was made; and, assuming that the specific gravity of the fuel is somewhat similar to that used on test, little or no alteration will be necessary under normal conditions. In very cold climates a higher pressure will be required in order to keep the vaporisers hot; in hot climates rather less, as the surrounding temperature will keep the fuel many degrees warmer, and in consequence the lamps will not have so much work to do. It should be remembered that any variation in the working pressure of a pressure feed service will necessitate a corresponding alteration in the size of the opening on the fuel feeders; a higher pressure requiring less opening, and *vice versa*.

Assuming that an accident has damaged any portion of the pressure feed outfit, and it is essential to maintain the engine in running condition, a temporary feed can be arranged by gravity; any suitable receptacle being mounted at a height sufficient to give rather more head than that obtained by the air pressure. Roughly speaking, there will be about  $\frac{1}{2}$ -lb. pressure for every foot in height. It should be noted that a burner arranged for a pressure feed does not give quite such good results with a gravity feed; and a slight structural difference exists, the pressure feed burner having a brass finger in the vertical passage, whereas for gravity this is replaced by a gauze wick. It will be seen that the repair to the pressure service should be effected as quickly as possible as the engine will undoubtedly require more attention when running on the make-shift service. The maintenance of heat on the vaporisers is of the utmost importance if easy running is to be attained; therefore, if the engine has to run persistently on a light load, the attendant may need to increase the pressure at which the burners are working, and possibly slightly reduce the air supply to the vaporisers. The most ready indication of these requirements will

be difficulty in maintaining even running, and a persistent tendency to cough; and there may be a show of moist oil round the joint of the vaporiser cover and the electrodes. Such a condition is a sure sign of insufficient heating, and must be corrected if sweet running is to be maintained.

### Gravity Fuel Feed.

This subject has been partially covered by the above remarks; but if an engine is intended for use with gravity feed, arrangements are usually made to adapt the burners and vaporisers to work at a head of about 3 feet or 4 feet. That is to say, the bottom of the fuel tank should be at least 3 feet or 4 feet above the burners; and for obvious reasons the fuel tank should not be more than 1 foot in depth, the level of the fuel being maintained approximately even, otherwise the variation in pressure may cause a marked difference in the heat of the vaporisers, or may give rise to trouble in the burners.

### Burners.

When operating correctly the flame is blue with possibly the merest trace of yellow in the centre. It is quite clean, and similar in appearance and condition to that obtained with an ordinary gas Bunsen burner. As the burners are of the self-vaporising regenerative type they should be correctly heated and started, or there will be difficulty in getting them into condition. Cleanliness, internally as well as externally, is most necessary to success. Even the grid at the end of the mixing chamber where the flame burns will need occasional attention, as there is a tendency for corrosion to take place round the holes, thereby impairing the quantity of air and vapour which can pass. For the same reason, if a nipple be allowed to remain too long in use, it may become either too large from constant use of the pricker, or too small from persistent corrosion around the orifice. A word of warning may not be unseemly; never, under any circumstances, tighten up brass screws on a burner while it is hot as at certain temperatures brass is so rotten that damage is almost inevitable, and stripped threads or possibly permanent leakages may result.



# Administrative Notes

## Argentina.

**T**HE *Boletín Oficial* (Buenos Aires) of December 10th publishes the text of the Regulations, drawn up by the Argentine Ministry of Marine, for the working of the wireless telegraph service of the Republic, which for administrative purposes in this connection is divided into two zones—viz.: (1) The maritime zone, comprising all the stations working in territorial waters and on navigable rivers, as well as those on land installed within a distance of 100 kilometres of the coast and the shores of the River Plate and 50 kilometres of the banks of the other navigable rivers; and (2) the land zone, comprising all other stations.

The maritime zone will be under the jurisdiction of the Ministry of Marine and the land zone under the Ministry of the Interior. No wireless telegraph station may be installed in the Republic without previous authorisation being obtained from the Ministry in whose jurisdiction it is desired to erect the station.

Articles 35 and 46 of the Regulations deal with wireless telegraph installations on merchant vessels. Merchant vessels carrying fifty or more persons on board must, unless they are specially exempted, be provided from the time they are put in commission with radio-telegraph installations. A similar obligation is in force for all vessels entering or leaving national ports. The equipment is at all times to have a minimum transmitting power of 200 kilometres (124 miles) in the case of river vessels, and 500 kilometres (310 miles) in the case of sea-going vessels.

The full text of the above-mentioned Regulations (in Spanish) may be consulted by the United Kingdom shippers interested at the Commercial Intelligence Branch of the Board of Trade, 73 Basinghall Street, London, E.C.

## Brazil.

We are notified that the Brazilian coast station at Fernando Noronha has been closed.

The Brazilian Government wishes to notify that they have decided to allow through their coast stations exchange of official telegrams, and also telegrams in clear language between the vessels and their passengers, on the one side, and the agents of the shipping companies on the other side, on condition that the telegrams of this latter class have no other object than the private interest of the companies and passengers.

## China.

The coast wireless telegraph stations at Woosung and Canton, completed for working last summer, have now started regular service; similar stations at Foochow and Hankow are expected to be completed within the next few months. The stations are all of the same construction, each being provided with two masts of a height of 200 ft., giving them a range of 700 nautical miles by day and at least 1,300 nautical miles at night.

## Italy.

With reference to the Ancona station, the opening of which has already been announced, the Italian Administration notifies that this station will use, for public correspondence, only wave-lengths of 300 and 600 metres, and not 1,200 metres, as previously advised.

## Japan.

Advice has been received from the Japanese Telegraph Administration to the effect that the coast stations at Choshi, Fukkikaku, and Dairenwan, will transmit messages to ships at sea regarding typhoons reported by the Central Meteorological Office at Tokio. No charges will be made for these messages, except in cases where ships have requested that such advices be specially transmitted to them.

When in the vicinity of these coast stations, operators should endeavour to receive these special typhoon reports when signalled broadcast, and deliver them to the commander against the usual messenger receipts.

### North Atlantic Ocean.

The Admiralty Hydrographer notifies that for the purpose of carrying on the ice observations and ice patrol service provided for by the International Convention for the Safety of Life at Sea, the U.S. coast-guard cutter *Seneca* left New York on February 15th, to proceed to the Grand Banks of Newfoundland.

During the period of ice observations the *Seneca* will be the only vessel employed on this duty; but when the ice has moved southward so as to make a constant patrol necessary, an additional vessel will be detailed for that purpose.

The experience of previous years has shown that a continuous ice patrol should be established about April 1st annually, and continued throughout the season of dangerous ice conditions.

#### WIRELESS WARNINGS.

Upon getting in touch with the ice the *Seneca* will send a report daily to the Branch Hydrographic Office, New York City, at 4 a.m., 75th meridian time, addressed "Hydrographic, New York." An endeavour will be made to communicate direct with coast wireless telegraph stations, but should the *Seneca* be unable to communicate with any of these stations the message will be relayed through any vessel within reach.

The ice information will be given in as plain and concise a form as practicable, and will state the following:

- (a) Ice (berg or field).
- (b) Date.
- (c) Time (75th meridian).
- (d) Latitude.
- (e) Longitude.
- (f) Other data as may be necessary.

While on this duty the patrol vessel will endeavour by means of daily wireless messages to keep ships at sea advised of the limits of the ice fields, etc.

The *Seneca's* call letters are NRE, and she uses wave-lengths of 300, 600, and 750 metres.

### Pacific.

We have been advised that on and from February 1st, 1915, the ship tax on vessels equipped by the Marconi Wireless Telegraph Company of America, trading in the North

and South American service on the Pacific coast will be increased from two cents (2c.) to four cents (4c.) per word, and the coastal rate of the Pacific coast stations for the same service will be increased from three cents (3c.) to six cents (6c.) per word.

### Panama.

We learn that, in an Anglo-American agreement just concluded, arrangements have been made to obviate certain confusion which has been experienced in the working of radio-telegrams in the neighbourhood of the Panama Canal. This would appear to have arisen through the simultaneous sending of American and British naval and commercial messages. Certain hours of the day are allotted, under this agreement, to the uninterrupted operation of messages from warships, whilst the rest of the twenty-four hours is utilised by shore stations without naval interruption. The following special circular has been issued by the Marconi Wireless Telegraph Company of America concerning the use of wireless telegraphy in connection with the Panama Canal route:

(1) As soon as radio communication can be established with the canal, vessels should report their names, nationality, length, draft, tonnage, whether or not they desire to pass through the canal, require coal, provisions, supplies, repairs, to go alongside of a wharf, the use of tugs, probable time of arrival, length of stay in port, or any other matters of importance or interest. If this information has been previously communicated, through agents or otherwise, to the captain of the port, it will not be necessary to report by radio; but the probable time of arrival should always be sent.

(2) Control of radio-communication is entirely in the hands of the radio shore stations. No vessel will be allowed to interfere in the slightest degree with the canal radio stations; upon an order being received by a vessel at any time while within the waters under the control of the canal to discontinue using radio, even if in the midst of transmission of a message, she shall immediately comply.

(3) Upon a ship's arriving within the 15-mile limit, and until leaving the 15-mile limit of the canal zone, she shall transmit only with low power, not exceeding  $\frac{1}{2}$  kw.

(4) Messages to stations will be sent only to the Colon Station (NAX) when in Gatun locks and to northward thereof, and only to Balboa Station (NPJ) when in Miraflores locks and to southward thereof; between these two points ships may work to either station, preferably to the nearer one; the high-power station (Darien) at Radiol will not handle commercial work, and will not be called for canal business except in case of emergency.

(5) All messages between ships in the canal zone and ships at sea must be forwarded through the nearer shore station.

(6) Messages from ships in the Caribbean Sea for ships in the Pacific waters, or *vice versa*, shall be routed through the canal zone shore stations.

(7) All vessels fitted with radio, after leaving the terminal harbour to pass through the canal, shall keep an operator on watch until the further terminal harbour has been reached; this applies to the time when they are anchored in Gatun Lake, while passing through the locks, or moored to the lock walls, or to any of the wharves in the canal proper, as well as when they are under way. Messages relating to the ship's movements and the canal business shall take precedence over all commercial messages.

8. Pilots on vessels passing through the canal shall have the right to use a vessel's radio freely for the transaction of the canal business.

9. Under the direction of the pilots vessels will from time to time report their progress through the canal; accidents to machinery, propellers, steering gear, equipment or anything else that may delay them or require assistance; any sickness or casualties that require medical attendance from canal officials, or any other matter of importance that may arise.

10. No radio tolls, either coast station or forwarding, will be imposed against ships on radiograms transmitted by ships on canal business. There will be no charge made against the Panama Canal by canal zone land lines or radio stations for the transmission of radiograms to ships on canal business.

11. No vessel will be allowed to communicate with any lock or signal station while in transit through the canal, except through the pilot; all messages of any kind must be sent through him. This does not

apply to vessels moored at the terminals at Cristobal or Balboa, before entering or having passed through the canal, which may wish to communicate through the terminal stations.

On wireless telegrams received in relation to canal business from the canal zone radio stations, the "ship tax" of the receiving ships shall be charged against the sending radio coast station.

### A SUGGESTED SUBSTITUTE FOR A "BUZZER."

A recent number of the *English Mechanic* contains a rather amusing letter, referring to the Postmaster-General's notice concerning wireless apparatus. Mr. Howard J. Duncan, who writes the letter, states that it "may interest some of our wireless amateurs to know that a fair substitute for a 'buzzer' may be made by slipping the point of a dinner knife under a dinner plate till it reaches near the centre, and then operating the handle of the knife in the same manner as a Morse key. In this way it is possible to practise Morse without offending the Postmaster-General or infringing the Defence of the Realm Act." We note that Mr. Duncan does not consider this quite equal to the regular "buzzer," and only recommends it as a "stop-gap."

### MISCONCEPTION OF WIRELESS POSSIBILITIES.

Mr. Charles R. Gibson has been contributing long articles recently to the *Glasgow Herald* on the present use of wireless by the belligerents, and in the course of one of them tells an amusing story which, according to the writer, was repeated to him with portentous seriousness as an incident of the greatest gravity which had recently come under the narrator's personal observation:

"Two German workmen had been arrested as spies, and there had been discovered, hidden beneath the hearthstone of the kitchen in their two-roomed tenement house, a complete wireless installation capable of transmitting messages to Berlin."

Mr. Gibson comments that it is possible to send wireless messages as far as from here to Berlin, but not with apparatus that can be stowed away beneath a kitchen hearthstone, or even contained in a large room.



## NOTES OF THE MONTH

WE have received the following particulars of the departure of the S.Y. *Aurora* from Sydney.

“A full month behind the time originally fixed for her departure from Sydney, the *Aurora* left on December 14th for Hobart, en route to the Antarctic, where she is to remain for upwards of a year, not returning to Australia till March, 1916. It is expected that the vessel will reach her destination about the second week in January, and Captain Mackintosh and his staff will at once begin the preparations necessary for the safety of Sir Ernest Shackleton’s main party, which left Buenos Ayres over two months ago for the Weddell Sea, on the opposite side of the Antarctic Continent, and which will cross overland from there to Ross Sea on the Australian side. Mr. T. F. Knox received the following wireless message from Captain Mackintosh, leader of the expedition, last night: *Accept our first wireless greeting. To all kind friends adieux. We won’t forget Sydney.*”

The Union Steamship Company’s Tasmanian Mail Steamer *Loongana*, trading between Melbourne and Launceston, has just been equipped with a complete wireless telegraph set by the Amalgamated Wireless of Australasia, Limited. The equipment is of the latest type, and the engineering design of the apparatus is the result of long experience in the particular requirements of apparatus for shipboard use. The *Loongana* can keep in touch with the Melbourne Radio station all the way between that city and Launceston. Included in the equipment is a special emergency plant, which is designed to enable communication to be maintained independently of the ship’s dynamo. In case of accident the wireless plant could be operated as long as the wireless cabin (which

is on the uppermost deck) remains intact. This principle of providing such emergency equipments was inaugurated by Marconi’s Wireless Telegraph Company fully ten years ago, and its immense value in saving lives was first demonstrated when the ss. *Republic* went down off Nantucket Lightship in 1909, and the operator was able to maintain communication with several land stations and liners even while his ship was waterlogged and sinking. The system of the Marconi Company has been endorsed by the International Radiotelegraph Convention and by the Governments of the United Kingdom, Australia, Canada, New Zealand, and many others by making compulsory regulations for the use of this emergency plant on all vessels equipped for radiotelegraphy.

In view of the special trade in which the *Loongana* is employed and the short distance between her terminal ports, arrangements have been completed for a reduced charge for radiotelegrams to and from the *Loongana*. Messages sent by passengers on the *Loongana* to any address in Australia will be charged only threepence per word, the same rate obtaining for messages handed in at any telegraph office in Australia addressed to the ship. Only the actual number of words has to be paid for, as there is no minimum charge per message. The ordinary charge for wireless messages to and from ships registered in Australia or New Zealand was recently reduced to sixpence per word.

In his annual report Secretary Daniels, of the United States Navy, dwells upon several interesting phases of wireless telegraphy. He states that the navy department has opened twenty-five stations to commercial business and that every ship of the navy is herself a commercial station, as all private

messages handled are paid for by the senders. He points out that 300 jewellers throughout the country have installed wireless apparatus in order to receive the time signals sent out from the Arlington station, near Washington, and that the number may be expected to grow to 3,000, according to information received.

Referring to the radio compass now under construction at the Fire Island station, near New York Harbour, he says: "This device is intended to send out radio signals of such a character that a vessel in a fog may get a close approximation of her bearing, or compass direction, from the station. By means of observations taken five or ten miles apart it should be possible for the vessel to determine her actual position with fair accuracy. This is the first installation of this type to be made in this country; but a second installation of different type, though answering the same purpose, is projected for the station at Cape Cod. The signals sent out by the radio compass at Fire Island will necessarily be limited as to range, but the Cape Cod installation will allow of a ship calling the station in the usual manner from any distance within the ship's ordinary range and receiving a definite reply as to her bearing from the station. In the case of Fire Island the ship will determine her bearing from the character of the signals continuously emitted; for Cape Cod the station determines the bearing of the ship from her calling signal and sends the information back. If these installations prove as successful as anticipated, the radio operators of ships will become an important part of the navigating force."

We have received an interesting communication from the wireless operators on board the R.M.S.P. *Demerara* relating to the reception of signals at unusually long distances. They write: "At 11.10 p.m. on February 18th, while south of St. Vincent (Cape Verde Islands), we heard Land's End station (600 metre wave) a distance of 2,400 miles. At 11.45 p.m. the Paris time-signal was received. At 1.20 a.m. on the following morning (19th), just 2 hours 10 minutes after hearing Lands End, we heard Cape Race sending ice reports, signals very good, distance 2,600 miles. An hour later we heard Norddeich (Germany), distance 2,660 miles, signals remarkably clear. On the 20th,

when just south of Teneriffe, we heard Fernando Po (Gulf of Guinea), distance 2,040 miles.

\* \* \*

The *Montreal Star* recently published some thrilling experiences in the Antarctic of Sir Douglas Mawson, the Australian explorer, who recently arrived in New York on the Cunarder *Ordubia*. We understand that Sir Douglas intends shortly lecturing before the American Geographical Society on his experiences in the Antarctic during 1912 and 1913. In the preliminary remarks made to the newspaper reported, Sir Douglas claims to have discovered "the place where storms are spawned." According to this explorer, the breeding place of South American hurricanes can be shown to be Amelieland. It must be, indeed, the home of Boreas, for we learn that the wind there blows on an average fifty miles an hour, whilst during the trip Sir Douglas and his companions registered it as high as 220 miles on their wind gauge!

Swiftly, however, as the storm may travel, it is easily out-distanced by wireless "waves," and the exploring party discovered that it was possible for them to transmit news of the forthcoming arrival of hurricanes to the Australian coast at least *forty-eight hours in advance*. The immense utility of such a warning can scarcely be exaggerated.

\* \* \*

An account of "savage" wireless appeared in a recent number of the *Northern Daily Mail*. It is not uninteresting as showing the primitive use of the "musical note" which plays an important part in differentiating between the haphazard sounds produced by electrical disturbances in the atmosphere and those deliberately promulgated for the purposes of the transmission of messages. In the Juamara region of the Amazon the natives use a crude system of wireless telegraphy, which, it is claimed, has been in operation for thousands of years. The transmitter found by an explorer was a hollowed trunk of a tree suspended from a horizontal pole stretched between two stumps. Inside, the transmitter had been arranged much like a violin, and it was explained that when the instrument was struck smartly with a small rubber hammer a vibration was created that carried for miles over the hills.

# Doings of Operators

STAFF notes constitute the central feature of the February issue of the *Marconi Service Magazine*, and, amongst them, one stands out unmistakably as full of thrilling interest. It describes how M. L. Burgin and A. L. Cresse, first and second operators respectively of the s.s. *Camino*, distinguished themselves by heroic discharge of duty under circumstances of extreme peril.

Off the Newfoundland coast the *Camino* became helpless in a severe storm, 150 miles south-east of Sable Island and 220 miles from Halifax. So severe was the weather encountered that the wireless cabin was torn from its lashings, and the unhappy operators were reduced to assembling the apparatus together in a corner and continuing, under constant buffetings of wind and rain, to flash their signals. Despite these terrible hardships, they were able to obtain and maintain constant touch with coast and ship station. Through their agency the Canadian Government steamer *Lady Laurier* and other vessels were called to the assistance of the *Camino*, and one of the rescuers took her in tow. So fearful, however, were the waves that the hawser parted, and the *Camino* fell back into the trough of the sea. Eventually she succeeded in carrying her crew of thirty and her single passenger safely into port. The circumstances reflect the greatest credit upon the devotion to duty of these young men.

Two further examples of similar conduct occurred in recent days, one on the *Hanalei*, wrecked near San Francisco, in a storm, and the other on the *Chester*, whose rescued crew were brought to New York on February 9th by the *Philadelphia*. In the former instance the solitary operator, after his radio-equipment had been disabled by the breaking seas, although lashed to the mast, devised means of signalling to the life-savers on shore. He effected this through the agency of an electric light at the mast-head, presumably using the Morse Code by flashes. He kept the rescuers informed as to how the life lines were falling, and, by his signals, enabled them at last to "find the range" for their rockets.

In the latter instance the *Philadelphia*, in mid-ocean, sighted the *Chester*, a tank steamer with a captain and crew of 32 men. Mr. Jones, the wireless operator on the *Philadelphia*, attempted to get into communication by wireless, but failed, owing to the fact that the *Chester* had had her apparatus swept away. Here, again, the operator was able to signal, through the Morse Code, by means of lamps, and learned the state of affairs on board the *Chester*. They were about as bad as they could be; the ship was on fire, and had it not been for the resourcefulness of the operators on the respective steamers there is little doubt that all on board the *Chester* would have perished.

\* \* \*

Thrilling stories of rescue were told by survivors of the lost British auxiliary cruiser *Bayano*, which met her doom off Corsewall Point, Wigtownshire, and, according to the Admiralty's statement, was probably sunk by an enemy's torpedo. The loss of life is estimated at no less than 190, only twenty-six of her ship's company having been rescued.

While all the crew of the lost cruiser were heroes, the bravery of the captain, who was last seen on the bridge engulfed by the swirling waters, and of the *two wireless operators*, who were still flashing the "S.O.S." signal as the ship went down, stands out in vivid colours.

"Captain Carr behaved with great bravery," said one survivor. "As I left he shook me by the hand and said 'Good-bye.' He had no thought for himself, but every thought for his men. To one man who offered him a lifebelt he said, 'Good lad, save yourself.'"

One survivor stated he was below in his hammock when the ship was torpedoed. Two-thirds of the crew were in bed at the time and the other third on watch. All were wakened by the explosion, many being thrown from their hammocks. The explosion seemed to blow in the bottom of the vessel amidships, and volumes of water poured in. All made for the deck, which was awash, and in about three minutes the ship



sank bow first. They had enough rafts and boats, but not enough time to use them all.

All the twenty survivors of the auxiliary cruiser *Bayano* who were landed at Ayr were suffering severely from exposure, while four were, in addition, so badly injured by the explosion that they had to be taken to hospital.

\* \* \*

The record of wireless achievements in the way of rescue afforded to ships in distress is now becoming as long as it is honourable. We believe, however, that the following account, reprinted from the *Dundee Advertiser*, chronicling the part played by radiotelegraphy in bringing assistance to a Dundee steamer recently arrived, is worth calling to the attention of our readers:—

“The passage from Calcutta had been an uneventful one, but when the *City of Lincoln* entered the dreaded bay a furious storm burst. The ship at first withstood the shock well, but unfortunately the rudder post broke under the strain, and left the steamer at the mercy of wind and waves. The position was extremely precarious. Huge waves swept the decks, carrying away parts of the steamer's equipment, and strewing the passages with ropes and deck fittings; while at one time the peril became so acute that many of the lascars who form part of the ship's company leapt to the rigging and climbed the masts for safety. Meanwhile the wireless operator of the *City of Lincoln* was sending out calls for assistance. Three of his messages were answered, but the responding vessels were unable to afford immediate help. A fourth call was sent out at five o'clock in the morning, and the operator informed the anxious crew that the steamer *Raphael*, of Liverpool, had replied, and was steaming to their assistance. Working strenuously, the engineers temporarily repaired the damage, and at seven o'clock the hearts of the men were cheered by the arrival of the *Raphael*. Tow wires were expeditiously run out, but at the first strain one of these gave. Fortunately it was found that the *City of Lincoln* could proceed under her own steam, and she was taken into a small repair port in the north of Spain, where the broken rudder post was securely clamped. The storm had abated before this operation was finished, and she concluded her passage in safety.”

## SIGNOR MARCONI A SENATOR.

In the Senate on March 17th Signor Guglielmo Marconi was introduced to the House as a new Senator with the customary formalities. He was received with long and enthusiastic applause, in which the public in the gallery joined.

## TRANSATLANTIC WIRELESS.

We understand from the Copenhagen correspondent of the Exchange Telegraph Company that a commercial movement is on foot to establish direct wireless communication between Sweden and New York. Representations have been made to the Swedish Postmaster-General, who considers the scheme to be favourable, although he does not see any possibility of acting just now because of the uncertainty of the time it will take to erect a high-power station on Swedish soil. It is considered probable that Sweden will decide to use Marconi's new high-power station in Norway, which was specially built for communication with America. All Danish wireless schemes have been dropped.

## PATENT INTELLIGENCE.

275. January 7th.—WESTERN ELECTRIC CO., LTD. (Western Electric Co., U.S.A.). Electric wave amplifying apparatus. (*Complete*.)
433. January 11th.—CHAS. H. PARKER. Adjustable stand or holder for crystals used as detectors of electric signals in Wireless Telegraphy and Telephony. (*Provisional*.)
519. January 12th.—LUCIEN ROUZET. Polyphase generator for high-frequency currents with polyphase tuned spark-gap. (*Complete*.) (Convention date, France, January 12th, 1914.) (*Open to Public Inspection*.)
1402. January 28th.—EDWARD C. RUSSELL. Wireless apparatus. (*Provisional*.)
2076. February 9th.—CHAS. TUCKFIELD and W. G. DE FORGES GARLAND. Wireless aerial elevator. (*Provisional*.)
2585. February 17th.—JOHN PERRY and SIDNEY G. BROWN. Wireless Telegraphy and Telephony. (*Provisional*.)
2821. February 22nd.—RICHARD CARTWRIGHT and HAROLD J. BULL.—Means for increasing the oscillations in frequency of electric currents. (*Provisional*.)
3507. March 4th.—MARCONI'S WIRELESS TELEGRAPH CO., LTD., and RAYMOND D. BANGAY. Means for receiving signals by sound. (*Provisional*.)
3548. March 5th.—J. J. DENTON and ANDREW G. MACCULLOCH. Wireless control for operating machinery. (*Provisional*.)
3950. March 12th.—LEE DE FOREST and CHARLES V. LOGWOOD. Wireless receiving systems. (Convention date, United States, March 12th, 1914.) (*Complete*.)
3954. March 12th.—NAAMLOOZE VENNOOTSCHAP DE NEDERLANDSCHE THERMOTELERPHOON MAATSCHAPPIJ. Wireless Telegraphy or Telephony. (Convention date, Germany, February 5th, 1915.) (*Complete*.)
4017. March 13th.—AXEL UNO SERNMARK. Devices for Wireless Telegraphy and Telephony. (Convention date, Sweden, March 13th, 1914.) (*Complete*.)

CARTOON OF THE MONTH.



A German Submarine Crew Working on a Higher Aerial.

# New Applications for Wireless.

## No. 1.—The Case of the Empress Music-Hall.

By W. B. COLE.

**A** FOGGY evening in January, about 8.30 p.m. Two men are walking along the Strand in the direction of the West End. The pockets of their overcoats bulge considerably, and render it hard for them to thread their way along the pavement without collision.

"The first house clears out at 8.45," says the elder of the two, "and if we are quick we shall be quite ready for our little 'turn' in case our prey come on early in the programme."

These are not music-hall artists *en route* to fulfil an engagement, but simply two wireless enthusiasts with a theory to prove that night.

Clifford, the elder, is an old hand in wireless work, about thirty years of age, clean-shaven, fair, and rather tall. His companion is considerably younger, short and dark, and the proud possessor of a smile that wins all hearts, especially those of the ladies. He has only been in the wireless world about two years, and the two had met and worked together some months before on a large battleship wireless installation in the north of England.

A fortnight before, they had come together again in London, and had made up their minds to carry out an idea of Clifford's without delay. Now, after some days of preparation, they are on their way to put it to the test.

Outside the Empress Music-Hall, near Leicester Square, huge posters announce as a great attraction that the world-famed Signor and Madame Zanani would give that night their celebrated thought-reading entertainment; that anyone in the audience might hand to Signor Zanani any article, when his wife, blindfolded on the stage, would immediately give the name of it.

A quarter of an hour later our friends are

divesting themselves of their overcoats in a side box.

"I think we shall have time now before the curtain goes up," says Clifford, as he places a heap of queer-looking articles in the corner.

His colleague, having now taken his coat off, looks more like a living advertisement of Michelin tyres than a rational being: for his body is wound round with indiarubber-covered wire of a thickness equal to an ordinary finger.

"Oh, I prithee, turn me not round, my stomach is not constant," quotes our wireless "Stephano" as his friend starts unwinding him by the easiest process of forcing him round.

"We must be quick," replies Clifford. "Weston will be here in a few minutes."

Then follow a few minutes of intense activity. Supported by the hat hooks that Holland had brought, the two men fix the rubber-covered cable round the box until there are four complete turns.

"It's fortunate for us they haven't altogether abolished gas yet," says Clifford, as he screws a clamp on to the lead pipe of the jet. "This will make an excellent *earth*. Now, Holland, old man, you connect this end to the discharger while I join up the cells, and we shall have our first spark in a minute."

The box now constitutes a regular amateur wireless station. In the corner stand five dry cells connected to a small ignition coil, while on a chair is placed a little operating key. The big coil of wire hanging round the box above their heads is connected to one discharger terminal, while the other terminal of the discharger is joined by a length of thick wire to the clamp on the gas bracket. A pair of telephone receivers and a little box containing various coils, handles and switches form the receiver. This completes the essential outfit, bewildering to

anyone not acquainted with "wireless mysteries."

"Just mind yourself, old chap," exclaims Clifford, "while I try the spark"; and, as he speaks, he presses the small operating key.

A tiny crackling white spark flashes out between two small knobs, seen through the little glass window of the discharger box.

"O.K. and quite a good tone, and not too noisy to give the show away."

No sooner have the young engineers made their first test when there is a knock at the door, and the programme girl enters.

"Programme, sir?"

"Oh yes, thanks. I say—er—er—don't say anything of what you see here," says Clifford as the girl utters an exclamation of surprise. "We are not Suffragists, and there is not going to be any trouble." So saying, he slips something into her hand.

The girl promises and withdraws quite pleased.

"Good!" says Holland. "First possible opposition overcome by the usual means. I wish your friend would hurry up."

The orchestra by now has tuned up and are preparing to settle down to the night's business, when "May I come in?" says a voice.

"At last!" exclaims Clifford. "Come in; be careful where you tread. This is my friend Holland, co-worker and affectionately known as the 'damboy.' This is Mr. Weston, of the *Daily Thunderer*."

The men shake hands.

Mr. Weston, a special correspondent of the *Daily Thunderer* and a friend of Clifford's, is a tall, alert-looking man of about forty years of age, with iron-grey hair.

"Well, gentlemen," says Weston, looking round the box with an amused and semi-critical smile, for he had dabbled a little in wireless himself, "I hope I shall have the satisfaction of congratulating you at the end of the performance."

Meantime the house has been filling rapidly and the orchestra playing the overture. This soon ends, and No. 5 shows on the illuminated indicating board. This is the turn for which our friends have so carefully prepared.

The curtain rises and shows Signor Zanani standing beside his wife in the middle of the stage. When the applause subsides he advances, and after a few preliminary

remarks concerning the nature of their performance, he turns to his wife, who seats herself in a large, comfortable chair. Taking a large white handkerchief from her, he wraps it securely round her eyes and down over her nose, and Madame arranges it slightly over a corner of her mouth. Signor Zanani then turns the chair round so that his wife sits with her back to the audience.

An attendant places a small plank on the stage, extending from the footlights to the chair of the conductor, and Signor Zanani, crossing this, descends into the orchestra stalls and asks members of the audience to hand him any article they may have handy.

Many are immediately passed over. Taking a ring from a lady, he looks up at it for about five seconds.

"What is this?" he says, looking towards the stage.

Immediately come the reply, "A ring."

"And this?"—holding up a knife he has just taken from a gentleman.

Again the correct answer comes from the stage. Great applause greets this success.

"Now for our little turn," says Clifford in a whisper. "Give me any word you like, Weston, the shorter the better. You are supposed to be investigating this theory for your paper."

"All right," whispers back the correspondent. "Send 'pen.'"

Clifford's hand slides along to the operating key. "Dr-drrr-drrr-dr (pause) dr (pause) drrr-dr," crackles the spark in the discharger.

"What is this?" the thought-reader is saying down below, holding out a brooch.

A pause ensues. The conspirators lean forward, tense with excitement.

"A pen," come the words distinctly from the stage.

The men in the box jump.

"Done it, by Jove!" whispers Clifford—"first time!"

"A slight mistake on my part," says Signor Zanani, who is now right under our friends' box. "I will try again."

Holland has meanwhile put on the telephone headgear and is now busily writing on a paper pad. "Look here," he whispers.

His friends crowd over him. On the paper is written "p-k-t."

"And this?" the performer says, holding up a little object for the audience to see.

"Packet," comes the reply at once.

"Ain't that good enough proof for you, Weston?" says Clifford.

Again Holland busies himself with his fountain pen.

"C-g-t-s," spells out Weston, looking over his friend's shoulder.

"Packet of what?" inquires Signor Zanani.

"Of cigarettes," says his wife.

"Quite right," replies the performer; "and thank you, sir," handing back the cigarettes to the owner.

"It's jolly smart sending," says Holland; "he sent the word before he asked her what it was."

"Give me one word more, Weston," Clifford says.

"Send 'key,' then," replies he.

Again the tiny spark crackles out the dots and dashes of the Morse code.

"Key," answers Madame in response to the usual inquiry.

Signor Zanani by this time appears distinctly upset. "That is not quite right," he says; "and I should like to say here, in explanation of this apparent failure, that such accidents occasionally occur on a disturbing day. Objects which are associated with one another are often impressed on my mind, and so are conveyed to the mind of my wife, who is so much attuned to me. In that case Madame receives that word instead of the right one. For example, I am holding a watch in my hand, and my wife in this peculiar way receives the word 'key,' or the impression of a key. By the way, this watch has a key attached to it. The two,





you see, ladies and gentlemen, are intimately associated."

"Ingenious old chap, isn't he?" whispers Weston, "and on such a short notice too."

"I will increase the power and keep the key down for half a minute," says Clifford, "and let us see what will happen."

He kneels down in the corner and connects three more cells into the circuit. "Go ahead, Holland"; and Holland presses the key at the same moment that Signor Zanani is taking further articles from the audience.

"What is this now?" he says.

There is no reply from the stage. Signor Zanani looks expectantly, but still there is no reply.

"Switch off!" says Clifford quickly, as the lady rises from her seat and clings to the edge of her chair.

Signor Zanani dashes up the plank and runs towards his wife, at the same time with impatient gestures indicating that the curtain should be dropped.

"There is no harm done," says Clifford, as Weston and Holland look a little uncomfortable. "Zanani will come forward in a minute and tell us that all is right."

The curtain had dropped rather clumsily, and so suddenly have the above events taken place that the audience are taken unawares. Now a buzz of conversation runs through the house.

A few seconds elapse. The curtains part and Signor Zanani steps forward and makes the following announcement:

"Ladies and gentlemen, I sincerely regret having to end our performance abruptly owing to the sudden illness of my wife, although I am glad to say that she is suffering from nothing more serious than a fainting fit. I trust you will excuse us for to-night, and we shall hope to be with you to-morrow. We thank you heartily for your appreciation."

"Excellent English and well delivered for a foreigner," says Weston, smiling. "I wonder if he is really a 'Signor'? Perhaps it pays better."

The "Signor" now retires, bowing his acknowledgments; but ere he disappears behind the curtain he glances swiftly but suspiciously along the rows of boxes.

"He guesses there is a jamming station somewhere up here," says Holland. "I think we ought to dismantle the gear, as he

might get the manager to come round on an inspection on some pretence or other."

In four minutes everything is packed away in their overcoats, Weston taking his share. They are not a moment too soon, for in the next box can be heard the voice of the manager making an excuse for his intrusion.

"I will ring for drinks," says Clifford, reaching out and pressing the electric button. "Open the door, Holland, and call out for the waiter."

Holland steps out of the door just as the manager comes out of the adjacent box.

"Good evening, gentlemen," says he, advancing towards their door. "I am the manager, and I am sorry the last turn ended so abruptly. I am just running round to a few of the boxes to explain that all is well."

"Oh, come in, by all means," says Clifford. "Sit down. Will you have a drink?" as the waiter appears at the door.

"No, thanks, really," replies the manager; "I have too much to do before the next two turns. Kindly excuse me," and he hurries out.

"He is gone," remarks Holland, with a smile. "I think we ought to cut too, for I saw the business manager enquiring very earnestly of the programme girl. I gave her a wink, but he may have some idea of questioning us, and there may be some liability for disturbing a show."

"Come to my club and have supper," says Weston, "there are lots of little things that are not quite clear to me, and I must know them before I write my article."

An hour later the three have finished a delightful little supper in a private room at Weston's club, situated in one of those quiet squares not far off Fleet Street. They have been sipping their coffee and liqueurs for the last five minutes while Weston has been filling several small sheets with shorthand notes.

"Now I am ready," he says, turning to Clifford, "to put you into the witness box. I can understand Zanani's transmitting arrangements more or less. No doubt for an aerial he had something like ours, only wrapped round his body."

"Yes," interrupts Clifford, "but ours



was earthed to the gas jet and sparked plain aerial fashion. I think his aerial was more likely in two parts—one wound round his body and the other part round his leg or legs, but both adjusted to the same wavelength."

"And he sparked it in the middle?" enquires Weston.

"Yes," replies Clifford, "from a small coil like ours, but well silenced. It is possible," he continues, "that he had a similar aerial to ours, and for an earth he might have had metallic soles in his shoes. His wife then would have the same arrangement."

"That's quite clear and straightforward," says Weston, making a few notes; "but how did he send? I particularly noticed he did not have his hands in his pockets on a hidden key."

"That," replies Clifford, "could be done in many ways, but the best method I can think of is that he used his big toe. Wait a moment," he continues, as Weston starts laughing. "If you have comfortable boots, you will find there is plenty of room to move your big toe considerably. It would only need practice and a specially designed contact plate for anyone to be able to send quite ten words a minute; and you remember he abbreviated his words. 'P-k-t' meant 'packet,' was one example; 'C-g-t-s' for cigarettes, another."

"That's excellent," laughs Weston, "but here is the hardest nut to crack. How did Madame receive, for she had no telephones? I'll swear to that, for I was watching her carefully through the glasses when Zanani was bandaging her eyes, and she was not secreting any instrument inside them."

"I think I have the explanation of that too," says Clifford. "Did you notice that one corner of her mouth was covered with the handkerchief? In fact she arranged that herself."

"Now you mention it, I *do* remember noticing it," answers Weston.

"And," continues Clifford, "I feel sure the receiver was in her mouth. She had a similar aerial to that of her husband, but with a jigger in the middle, with the secondary wound for some kind of oscillation rectifier, probably a crystal or combination of crystals. The direct current produced

was taken to the receiver in her mouth by two wires. They were probably flesh-coloured and there from the beginning; but the actual receiver is the smartest thing of the lot. Any elementary book on electricity will give you the various known methods of detecting electric current, and when all are considered there is only one, in my opinion, that could be used in this case, and that is the physiological one. The lady felt the messages, or rather tasted them. One of the first experiments I ever did in electricity was at school. In the first chapter of our class book on electricity it describes a simple experiment of putting a copper coin under the tongue and a silver one on top. Nothing happens until they touch, when a coppery taste is noticed. 'That,' says the book, 'is due to the electric current passing through the tongue.' Now, applying that idea to our lady, let us assume she possesses false teeth."

"Ah, ha!" chuckles Weston. "I understand. I will finish the tale. Two wires from the rectifier enter her mouth and are attached to her dental plates."

"Just so," said Clifford; "it is the old experiment reversed. Current is supplied to the plates from an outside source, and the plates need not be dissimilar in material in this case, I suppose. It may be the lady receives the messages in a series of neuralgic pains or spasms. But I am not sure it was all done that way," says Clifford, "although it seems to me the most probable."

Would you care to join us next Saturday evening, say, first for dinner at seven-thirty at Frascati's?"

"Rather!" cries the correspondent. "A thousand thanks for the chance. Shall I want my revolver?"

"Yes, you might bring it," says Clifford, "it is sometimes a good argument; and you might also bring with you two forks and a spoon."

Well, anyway, I think we've done a pretty good night's work and thrown an unexpected bombshell into the Zanani camp. Now, Weston, Holland and I have been experimenting on similar lines with another physiological receiver, and I have something rather more serious to propose. This time it may be dangerous, and will most certainly prove exciting.

## "WIRELESS WORLD" INDEX AND BINDING CASES.

The Index to Volume I. of THE WIRELESS WORLD is now ready, and will be sent free of charge to any reader requiring a copy, provided a penny stamp is sent with the application to cover cost of postage.

Cloth cases for binding the first volume of THE WIRELESS WORLD have also been prepared, and these are on sale at 1s. each (postage 3d. extra). A limited number of bound copies of Volume II. of THE WIRELESS WORLD are available, price 4s. 6d. net each copy (postage 6d. extra).

Applications for binding cases and copies of bound volumes should be sent with full remittance to the Wireless Press, Ltd., Marconi House, Strand, London, W.C.

## A WIRE WINDING "PEN."

By P. J. PARMITER.

IT often happens that the wireless experimenter is faced with the problem of having to wind a given quantity of fine wire around two or more mandrels having a limited space between them. For this purpose the wire "pen" may prove useful. As can be seen from the dimensioned sketch, it consists of a glass stem, S, having one fixed and one loose brass collar (C C<sub>1</sub> respectively). To the loose collar is soldered a strip of stiff brass about  $\frac{1}{2}$  inch wide, bent twice at right angles, and having a hole through which the glass stem can freely pass. Two smaller holes take the short axle on which the reel of wire can turn easily—for which object it may be bushed with a short length of brass or glass tubing.

The length of the arms, A A, should not be less than their distance apart.

The glass stem may be purchased at a chemist's for 1d.; its ends are rounded off by heating in a Bunsen flame (turning the tube meanwhile), the lower end being heated until only a fair-sized pinhole remains.

The opposed edges of the brass collars should be quite smooth, so that the upper one can turn easily. The lower one, C, is fixed to the glass by Canada balsam, which, by

the way, is about the best substance to use for small "brass to glass" jobs.

The use of the device is self-explanatory, the points which make for its efficiency being free movement of the reel and correct

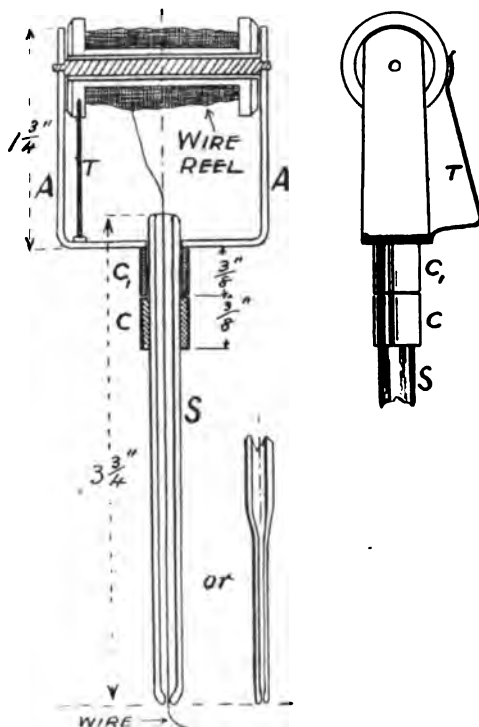

height of the arms, A A; it will then be found of service in small jobs with wires of No. 36 and under. A feeble spring, T, may be added if so desired, as it will assist in keeping the wire taut.

## WIRELESS CONTROL SHIP.

According to the *Journal Télégraphique*, the United States Government has equipped a vessel with apparatus for quickly measuring wave-lengths; it will cruise in the Atlantic, and will ascertain whether wireless stations conform to the rules relating to the wave-lengths that they must use. It has been noticed during the past year that the regulations are often neglected. The control ship will also take steps to prevent the emission of alarm signals in cases that are not urgent, as has often happened.

# The Amateur Handyman

## A COMPACT WIRELESS RECEIVING SET.

By J. STANLEY.

**I**N the following article I hope to have succeeded in explaining and giving ample instructions to enable any amateur to construct a wireless receiving set similar to the one I have made, and which will pick up the weakest amateur signals, and also the largest commercial stations.

The set is enclosed in a box 12 in. by 12 in. by 10 in., which contains everything necessary—viz., a loose coupled inductance, 3 variable condensers, made up of 26 separate condensers, 4 detectors, potentiometer, battery, and 'phones. The whole is worked from the top board by means of switches, thus giving the maximum of variations with the minimum of trouble and time.

*To commence work.*—First construct a strawboard tube with wood ends, 10 in. long and 5 in. diameter, well shellac over all, and when dry mark the length out into 12 equal spaces, as in fig. 1. Then sub-mark the first

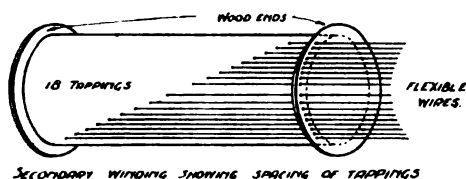

Fig. 1.

of the 12 spaces into 6 equal parts, and begin winding very closely and evenly as much No. 38 S.W.G.D.C.C. wire as it will take, leaving a small twisted loop about  $\frac{3}{4}$  in. at each mark on the tube, which, when finished, should have 18 tappings, including both ends, well shellac, and let dry. Then bare the ends of tappings for about  $\frac{1}{2}$  in., twist, and solder to each one a length of about 18 in. of single flexible wire to allow of connections to studs. It is best to strip off the cotton covering on the flexible, leaving only the rubber insulation, and, where the wires are soldered, it is essential to insulate well from each other by means of a small piece of

rubber tube. This done, shellac over all again and let thoroughly dry, when it can be

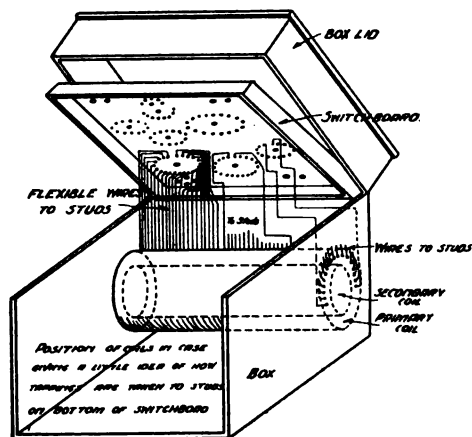

Fig. 2.

handled without fear of injuring the windings. This will complete the secondary winding.

Next prepare 2 hardwood circles 6 in. diameter, drill 18 holes  $\frac{1}{8}$  in. apart and  $\frac{1}{4}$  in. from the edge in one of the pieces, and screw to the ends of the secondary coil, taking care to get the holes on top on the right-hand side of coil, that is the finishing end, then thread the flexible wires through the holes already made (see fig. 1), bunch together and tie up, in order to protect them while winding the primary, which is made as follows:

Obtain another piece of strawboard, 11 in. wide and 20 in. long, tack on to the edges of the 6 in. wood circles, and so form another tube with the secondary coil inside, leaving only the 18 tappings outside through the holes, shellac well and dry, and commence winding on No. 28 S.W.G.D.C.C. wire, leaving a twisted loop every second turn, up to 51 complete turns, which will mean 26 tappings, then mark out the remaining space on coil into 24 equal widths and finish winding, leaving a loop at every mark, making another 25 tappings—in all 51 tappings—shellac well, and dry, when it can be mounted in box, which can be made of any hardwood suitably prepared, about  $\frac{3}{8}$  in. to  $\frac{1}{2}$  in. thick.

Coils may be secured by screws to the sides of box, care being taken not to let it touch either the bottom or back (see fig. 2). Obtain a piece of ebonite, 12 in. square and about  $\frac{1}{8}$  in. or  $\frac{1}{4}$  in. thick, cut to fit inside the top of box flush with the top edges, then mark out circles for studs, switches, and terminals (positions and numbers of which can be seen on photograph of switchboard), drill all holes, and screw on  $\frac{1}{2}$  in. by 1 in. frame, all round the bottom edge of the ebonite sheet, which, by so doing, will be strengthened and kept flat, then fix the board by means of hinges to back of box, as in fig. 2.

The detectors are made as follows: Obtain or make 4 pieces of angle brass, about 2 in. by  $\frac{3}{8}$  in., drill hole on the top and bottom,

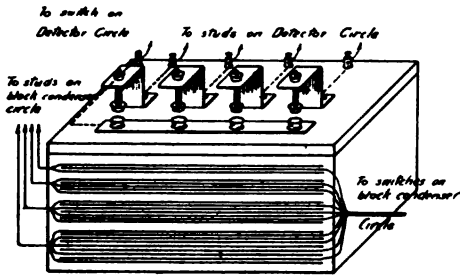

Fig. 3.

and screw on to a hardwood base 4 in. by 3 in. (as in fig. 3), about  $\frac{1}{2}$  in. from the back edge and equal distance apart, then obtain 8  $\frac{1}{2}$ -in. brass screw caps from any gasfitter's, and drill a hole in 4 of them centrally, solder an  $\frac{1}{8}$ -in. brass thread about  $1\frac{1}{2}$  in. long in them, then place a brass spring on, put into angle brass and screw a small terminal on top. The other 4 caps can be soldered on a brass strip equally apart, and connections taken to terminals on back of base, as in fig. 3, which will enable detectors to be easily detached.

The crystals are put in a piece of tinfoil and screwed in cups, which will hold them very tightly, thus doing away with the need of soldering them in, which I think spoils their sensitivity. The block condenser is really 4 condensers of different capacity, being 3 plates 4 in. by 2 in., 5 plates, 7 plates, and 9 plates respectively, connections taken to studs and switches on board, which will allow of any one condenser to be used, or almost any value from the smallest up to the

full capacity of the two largest, to suit any phones. They are made in the usual way, interleaved with mica or waxed sheets, and connected as in fig. 3.

The other 22 condensers, 11 each for the primary and secondary circuits, are made up of thin zinc (obtained from an export match case) in the usual way, and consist of No. 1, 3 plates 1 in. square; No. 2, 3 plates  $1\frac{1}{2}$  in. square; No. 3, 3 plates  $1\frac{1}{2}$  in. square; No. 4, 3 plates  $1\frac{3}{4}$  in. square; No. 5, 3 plates 2 in. square; No. 6, 3 plates  $2\frac{1}{2}$  in. square; No. 7, 3 plates 3 in. square; No. 8, 3 plates  $3\frac{1}{2}$  in. square; No. 9, 3 plates 4 in. square; No. 10, 5 plates 4 in. square; and No. 11, 7 plates 4 in. square. Solder on flexible wires, long enough to reach the studs, and number them as you go on so that you get them to the proper studs, assemble, and box up, connections to be made as in fig. 4—viz., No. 1 condenser to the second stud on primary circle, and so on. Make another set exactly the same for the secondary circuit, and repeat the connections to the secondary circle.

The potentiometer is very simple, being a length of high-resistance wire wound on a wood roller with wood ends, and 12 tappings being soldered on, one on every second turn, and the 2 ends to terminals on top.

An insulated double switch will be required for the secondary studs, to enable the user to pick out any one or number of sections, and by turning the contacts round towards the last stud (keeping them the same distance apart) you vary the distance of that particular section or sections in relation to the primary, thus varying the

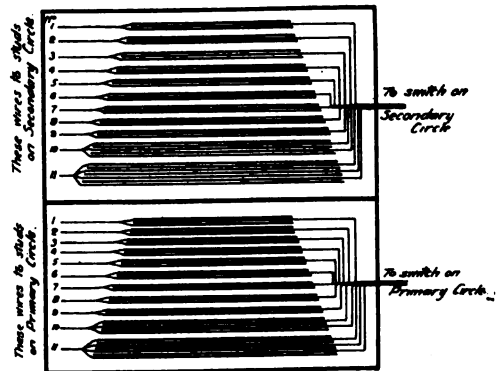

Fig. 4.

coupling. The small change-over switch is used for placing the primary condensers either in series or parallel.

The double switches (not insulated from each other) on the block condenser studs will enable you to use any one condenser, or almost any value up to the full capacity of the two largest.

The contact switches and studs can be bought of almost any electrical dealers, or can be turned up in the lathe, and are very simple to make. Six switches and about a gross of studs are required; the other two small switches can be made out of any scrap you may have to hand. You will also require six good-size terminals, two each for battery and 'phones, and one each for aerial and earth.

When all parts are made and assembled, the connections are made as follows: Connect up the flexible wires from the primary coil, the first wire to the first stud on the primary circle of studs, and so on up to the last wire of the small sections, then the first wire of the larger sections on to bottom of switch on primary circle, the second wire to the second stud on large primary circle of studs, and so on up to the last, leaving the first stud dead, then on to switch of large primary circle a wire straight to the terminal, E, then the first wire of secondary on to the first stud of secondary circle, and so on up to the last. The connections of condensers are, first wire to second stud on condenser circles, and so on, and the bunched wires to the switches, thus by using the switch you can pick out any one condenser, making them variable.

The potentiometer is connected in the same way, as are also the block condensers and detectors, and all other connections are to be seen in the diagram.

The lid of the box can now be made and hinged on and the whole box then finished to suit the maker's taste.

The aerial is 30 ft. high by 38 ft. long, two-wire spreader type using No. 20 S.W.G. bare copper with a lead to instruments of about 20 ft., the water pipe being the earth. 'Phones used are 3,000 ohm resistance, being bought secondhand, and the results obtained are all that one can desire, Paris and the Admiralty being read with the 'phones lying on the bench, and, as to tuning, either station can be tuned out at will, when both are sending together.

## WAVES

*Thoughts inspired by a Lecture given by Dr. Erskine-Murray before the London Wireless Society.*

"No rock so hard but that a little wave  
May beat admission in a thousand years."

IT seems a little strange that an abstruse subject like wave motion should be demonstrable by such homely analogies as were used to illustrate Dr. Erskine-Murray's lecture on "Waves" before the London Wireless Society last month. The royal and only road to a lucid understanding of wave-motions is to visualise them by studying the simple analogies which are always more or less readily available. Dr. Murray showed clearly how fascinating such a study might be made.

What he said and did has been referred to in another place (see page 41). Our purpose here is rather to refer to what the lecturer seemed merely to hint at. His suggestions regarding the psychological effects of wave-motions on individuals must have set many of his audience thinking along quite original lines. He cited the soothing effect of the wave-motion called waltzing and the thrill imparted by the "roll" of the kettle or side-drum.

The lecturer's references to, and illustrations of, the complicated wave-forms involved in speech and music were especially interesting in view of the developments now taking place in radio-telephony. Although the sound waves of speech and music are periodic motions of the air, it is on the ether waves that their complicated forms have to be impressed for transmission in radio-telephony. Radio-telegraphy employs only groups of comparatively simple waves.

We have, perhaps, all some more or less complicated wave-forms as peculiar to ourselves as our thumb-prints. Would not such a theory account for the very peculiar effect some musical airs have on individuals? For instance, Handel's Largo and some of Grieg's works have a deeply emotional effect on certain persons.

One might conclude that Adelaide Proctor, when she wrote the "Lost Chord," had a sub-consciousness of this phenomenon. The words "came from the soul of the organ and

entered into mine" may well have a scientific explanation. The same underlying idea or principle may unconsciously have inspired the writer of the frivolous song in *The Chinese Honeymoon* about someone's favourite "twiddley bit."

The writer was once on a ship the captain of which was, very properly, a strict disciplinarian and the wireless operator a good pianist with certain other qualities. The operator had studied the musical susceptibilities of the captain and other officers, and would sometimes make them the unconscious subjects of much fun by improvising music which included the "twiddley bits" by which each were respectively most affected. On occasion he would succeed in warding off trouble with the same persons by similar means.

Many commonplace periodic motions which have never been suspected of a scientific explanation occur to one. We do not rock the baby's cot for nothing, nor is it from caprice that the baby is most soothed by a periodic motion of a particular frequency.

It may be that some day what is now regarded as a cranky theory will become an exact science, and one would like to know what Dr. Erskine-Murray thinks of the possibility.

## AN AUSTRALIAN INCIDENT

### *Hospitality Repaid by Treachery.*

IN our last number we devoted considerable space and prominence to emphasising the necessity for wireless amateurs placing themselves unreservedly in the hands of the British authorities with regard to their apparatus. We trust that our appeal, grounded on patriotism as well as self-interest, will have been effective. Our attention has recently been called to a paragraph in this connection which was cabled over from Australia. At Melbourne, as recently as an early date in March, the military authorities seized a wireless plant at the residence of an employee of the Western Electric Company named Bleek. The man was of German parentage, in constant touch with his relatives in the Fatherland, to which country he was in the habit of paying frequent visits. The fact that this discovery only occurred eight months after the war had been in operation points to the necessity for continuous and unceasing vigilance.

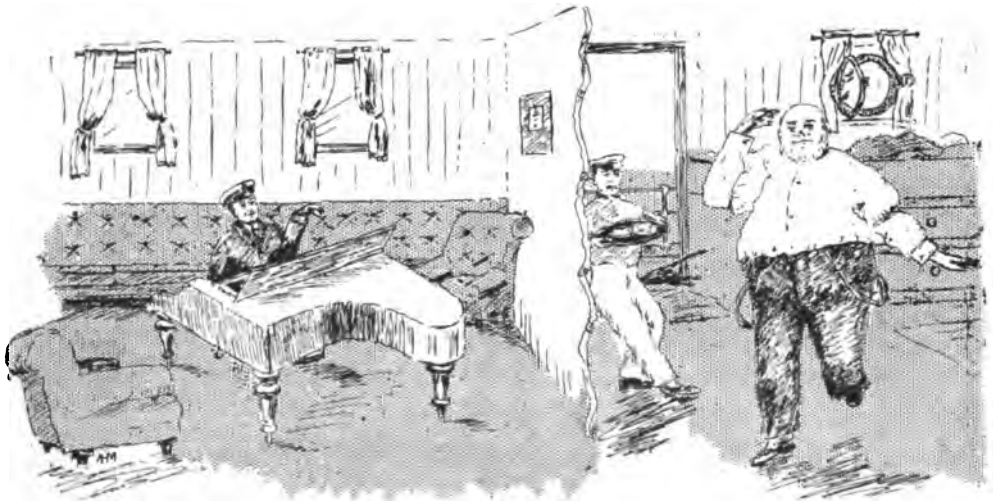

*Waves and Wave-emotions.*



# Among the Wireless Societies

## *Notes on Meetings and Future Arrangements.*

**Wireless Society of London.**—Dr. J. Erskine-Murray, F.R.S.E., gave a most interesting lecture at the meeting of the Wireless Society of London on Tuesday, March 9th, on "Waves." The lecturer did not go into any of the properties of electrical waves nor their functions in wireless telegraphy, but gave a discourse on the subject of waves in general, and merely hinted here and there the analogy between waves produced mechanically and electric waves. The various simple experiments demonstrated the lecturer's points without the aid of mathematics of any kind. Waves, explained Dr. Erskine-Murray, are enormous in number and enormously important. There are sea waves, sand waves, light waves, heat waves, electric waves; all of them periodic motions. There were cases where the periodic beat of a steam engine in a factory got into time with the natural spring of the floors, and if that went on for any length of time the building would inevitably come down; indeed, that had actually happened, owing to the superposition of the slight impulses of the engine on to the natural vibration of the building itself. This showed, he said, how important it was thoroughly to understand waves. A first and most important property of waves, especially in wireless, was to understand that they can cross each other at any angle whatsoever without in the least disturbing each other. This was demonstrated in an interesting way by ripples on water. Dr. Erskine-Murray said this explained why any number of sending stations near one another do not interfere with each other. The water experiment, projected on the screen, showed the waves distinctly crossing each other without the least interference. The motion of wind on water was next considered, and the fact that the formation of waves is a to and fro motion was explained. The same was true, said the lecturer, of electric waves. It was not a mass of electricity rushing along, but a to and fro motion, a motion transverse

to the direction of the waves. Finally, consideration was given to the effect of one vibrating body on another. This was demonstrated by springs of different sizes and by weighted rods. When motion was transferred from one to the other, the vibratory motion went on until all the energy has been used up in friction. In the same way, the discharge of an electric spark did not cause the motion of the electric wave to come to an end. Further experiments illustrated mechanically the effect of an oscillatory circuit, and showed how the energy was first transmitted from the primary to the secondary and back again from the secondary to the primary. The last experiment was with oscillators operated by water waves, the object being to show how a vibrator picks out its own set of waves, corresponding to tuning in wireless telegraphy.

\* \* \*

**Bristol Wireless Association.**—A special meeting of the above Association was held at 8 p.m. on Saturday, February 13th, at 141, Redland Road. Those present included Mr. A. C. Davis, who acted as deputy chairman in the absence of Rev. W. P. Rigby, also Messrs. Davis (Junn.), Duggan, Eason, Elkins, Parsons, White, Fawcett and Noble. After considerable discussion it was decided not to join the Model Engineers' Society this year, but, should occasion arise, the matter would be further discussed at the next annual general meeting of the Society of Model Engineers, and terms of amalgamation would be agreed upon. Mr. Davis consented to read and explain the first instructional article in *THE WIRELESS WORLD* at the next meeting. Messrs. Léfébure, Duggan, Parsons and White were elected members of the Association.

\* \* \*

**Institute of Radio-Engineers.**—At the annual meeting of the Institute, held at Columbia University on January 6th, the election of the following officers for 1915 was

announced : president, John Stone Stone ; vice-president, Dr. Geo. W. Pierce ; treasurer Warren F. Hubley ; secretary, David Sarnoff ; managers, Dr. L. W. Austin, John Hays Hammond (Junr.), Robert H. Marriott, Guy Hill, Geo. S. Davis and Roy A. Weagant. Dr. Alfred N. Goldsmith continues as editor of publications, and three additional managers from the New York membership are to be appointed by the Board of Direction.

The Institute held its regular meeting at Columbia University, New York, on February 3rd.

Mr. John Stone Stone delivered a presidential address and a paper on "The Effect of the Spark on the Oscillations of an Electrical Circuit." The paper described the theory of oscillating circuits having sources of both linear and logarithmic decrements within themselves. Among those who discussed the paper was Professor Zenneck, of Germany.

The reading of the paper on "Wooden Lattice Masts," by Cyril F. Elwell, chief engineer of the Universal Radio Syndicate (Poulsen System), of England, which was postponed at the previous meeting of the Institute, followed Mr. Stone's paper.

Mr. Elwell's paper gave in detail the design, construction and guying of lattice masts.

\* \* \*

**Liverpool Wireless Association.**—Meetings of the above association will be held at Creamery Café, 56 Whitechapel, on April 1st, 15th, and 29th. Free classes are held in "Electricity and Magnetism" and "Ordinary and Wireless Telegraphy."

\* \* \*

**Stoke-on-Trent Wireless Club.**—We are informed by the secretary of the above club that, owing to the fact that the late secretary, Mr. Frank Gamment, has joined the Royal Navy as Electrical Artificer, and to other reasons connected with the war, it has been decided to temporarily suspend the business of the club.

\* \* \*

**Barnsley Amateur Wireless Association.**—The above association held their annual meeting on March 3rd. The following officers were elected for the ensuing year :

chairman, Mr. E. Harding ; treasurer, Mr. J. A. Carr ; secretary, Mr. G. W. Wigglesworth. During February the usual Morse practice took place and also the study of the theory of "wireless." The hon. secretary, in writing of the latter, says : "I should like to remark how much we are benefiting by the study of theory. Many old ideas on the subject have been exploded, and we find the more we learn the more there is to learn."

## WAR NOTES.

*By Our Irresponsible Expert.*

Extract from German Wireless Handbook : "Operators on Zeppelins, when getting into communication with land stations, must send in their "TR" the following information : distance, bearing, course, speed, and number of bombs."

"The following abbreviations may also be used :—

"*Question.* QVA ? Have you killed any children ? *ANSWER.* QVA7. I have dropped bombs on seven children.

"*Question.* QVB ? How many cabbage patches have you injured ? *ANSWER.* QVB3. I have injured three cabbage beds and one brussel-sprout.

\* \* \*

### KINDNESS OF BRITISH TOMMIES.

On several occasions recently our soldiers have helped the German aeroplane operators to get a good earth. Strange to say, the operators when picked up have shown very little gratitude.

\* \* \*

German wireless will in future be known as the Telefunking System.

\* \* \*

### GREAT WAR CONUNDRUM.

How often is Poldhu ? *ANSWER :* Every Nauen then. (Copyright in civilised Europe and also in Germany.)

\* \* \*

Another rumoured Defence of the Realm case. Three months for a man for possessing a Morse Key and a Noah's Arc.

# Wireless Telegraphy in the War

*A resumé of the work which is being accomplished  
both on land and sea*

THE paragraph from *Indian Engineering* reprinted in our issue for March, on page 789, has brought us a letter from the Netherlands Legation in London, as well as several letters from correspondents of Dutch nationality.

The Netherlands Minister informs us, by order of his Government, that the article from *Indian Engineering* about the Dutch wireless station at Sabang is contrary to truth, and states that the radio-telegraphic station at Sabang, Poelwe Weh, is not a German station, nor is it served by German telegraphists. The establishment was installed originally by a German company (Telefunken), but the station belongs to the Netherlands Government, and since the opening for the public—September 8th, 1911—it has been served exclusively by Netherlands Indian officials who all are Netherlands subjects.

As is the case with all the other Government stations, the most scrupulous care is taken at Sabang that not a single telegram is sent which should be contrary to the strict neutrality which the Netherlands have declared to maintain. The most explicit instructions in the matter have been given.

Our private correspondents also have made very clear the careful precautions taken to prevent the possibility of any abuse, in the enemy's interests, of the facilities of wireless in the Dutch colonies.

We are pleased to take this opportunity of saying that the goodwill and sense of fair play manifested by Hollanders is as much appreciated by the wireless world as by all sections of the British community, both at home and abroad.

\* \* \*

The thrilling account of the Falkland Islands engagement which we were able to print on pages 766-8 of our March issue has not unnaturally attracted considerable attention from the daily Press, and has brought many congratulations direct to this office.

War is a great teacher of geography, and it is quite likely that, until this British naval victory occurred off its rocky coasts, a large number of newspaper readers would have been puzzled to give even a general indication of the whereabouts of this interesting British colony in the South Atlantic. It is instructive to note that the Falkland Islands group was first sighted by the British explorer Davis, in 1592, and received its present name, about one hundred years later, from another British navigator, Captain Strong. Twice occupied by France (1764 and 1770), it was purchased, in the eighteenth century, by Spain, who, immediately after spending her money, was compelled to surrender her claim by an ultimatum from the British Government. Between 1833 and 1852 it was utilised as a British penal colony, but this state of affairs came to an end at the latter date. Our illustration on page 44 will give some idea of the rugged nature of its coasts, and we cannot help wondering whether this resemblance to "Caledonia, stern and wild" accounts for the fact that the greater number of the settlers are Scotch. Our picture on page 45 depicts the outlying portion of Port Stanley, the wireless station, situated on Cape Pembroke, about two miles off. This was opened for public service on November 1st, 1913, and the night range thereof extends to about one thousand miles. A full description thereof will be found, under the title "An Outpost of Empire," on pages 81-84 of our May, 1914, number.

\* \* \*

Reverting to the account of the naval engagement from the pen of Mr. W. D. Lacey, the wireless operator of the Falkland Islands station, we are not surprised to find that the imaginations of a large number of people have been fired by the incident, first recorded in this account, of the "Nelson touch" of Admiral Sturdee, with which he followed up the example of the "England

expects" message which preceded the victory at Trafalgar. The fleet under the command of our modern hero signalled as they passed into the engagement the wireless message "God save the King." We have since had this interesting item supplemented, through a source of irreproachable reliability, by a few further details. It appears that the British admiral proceeded to his task with all the calm composure of his race. When the approach of the German squadron was first announced his ships were engaged in coaling. He ordered work to cease, and issued instructions that every man should have a bath and his dinner before proceeding to "business." In the meantime the vessels steamed towards their enemies at half speed, and it was not until the seamen had been thoroughly refreshed that the men-of-war, in turn, were put in fighting trim. Then followed the order to steam at full speed for the engagement with their foes. The deliberation of the whole procedure indicates the absolute confidence of the British Commander in his arrangements. Incidentally, we may remark, it was ascertained from some of the prisoners taken that, when first the German Admiral heard that the British ships advancing to meet him bore the unmistakable appearance of battle cruisers of the first line, he absolutely refused to believe his men's report, so effectually had been kept the secret of their despatch and arrival.

\* \* \*

An interesting article, which has been followed up by correspondence, appeared recently in the columns of our esteemed London evening contemporary the *Globe*, dealing with the subject of the danger of the misuse of wireless telegraphy in the interests of the enemy. Of course, the more powerful the machine one possesses the more efficacious it is for misuse as well



The Rocky Coast of the Falkland Islands.

as use. But, on the whole, considering the fact that wireless telegraphy has practically entered into every phase of the present struggle, the amount of misuse has been extremely small.

The well-known author Mr. William Le Queux, one of the *Globe's* correspondents, narrates the steps taken by the authorities in consequence of a report by himself, and suggests further surveillance of German spies in England. The following letter, from Professor A. A. Campbell Swinton, appears to "put the matter in a nut-shell." We have pleasure in reprinting it:

"As President of the Wireless Society of London, Hatton Garden, and acquainted with the facts, I should like to be allowed to say that most of the statements made by your anonymous medical correspondent are untrue, and others are altogether misleading. For instance, it is contrary to the fact that any German, naturalised or otherwise, has ever been an official of the Wireless Society, which, moreover, is well known and includes among its members the majority of the most eminent exponents of wireless telegraphy in the country.

"It is also entirely incorrect to suggest, as does your correspondent, that the authorities have been supine as regards illicit wireless telegraphy since the breaking out of the war. On the contrary, I am in a position to know that they have been most active, while it is also within my knowledge that they have most carefully considered all aspects of the question from time to time.

"I hope that the above is enough to show how little value should be attached to your correspondent's alarmist statements."

\* \* \*

On pp. 62 to 64 will be found some interesting particulars relating to the



A Corner of Port Stanley Harbour.

fitting of wireless apparatus on air craft. The arrangement of wireless apparatus under such conditions presented, as may be easily imagined, considerable difficulties. These, however, have been largely overcome, as the following report from the General Headquarters of the British Expeditionary Force will testify:—

“The programme arranged for us began with a visit to the aviation park, within a short motor-car ride of the town. At this point the air patrol service is centred and controlled. A record is kept of every flight and its success or non-success, that is, whether information was obtained and proved to be correct, carefully tabulated for reference. Every aeroplane is tended by two mechanics, one for the engine and one for the planes and frame. The result of all this care is the gratifyingly small proportion of accidents among the Army airmen.

“A walk across muddy fields brings one to the quarters of the wireless aeroplane section. This section, divided into flights of four machines each, consists of aeroplanes fitted with wireless telegraphic apparatus capable of transmitting signals to the receiving station at the aviation park. It has been found possible, as the result of a wireless signal from the air, for the artillery to locate and hit a moving target before it could reach shelter.”

\* \* \*

Cousin Jonathan always likes to claim

that he has the “biggest thing on earth.” One of his recent achievements in the military line is a portable field station, which, employing only a 2 kw. generating set and an equipment capable of erection in ten minutes, finds no difficulty in transmitting eight hundred miles under favourable conditions. Exactly how this is done we are not told, but the Signal Corps Laboratory has been kind enough lately to allow the publication of just sufficient technical details (reproduced in the February *Wireless Age*) to arouse at once our wonder and our appetite for more.

\* \* \*

WS. are the call letters of this station. They do not figure in the Government lists, but are stated to be unmistakable when in competition with the ordinary traffic. The station which was completed about five months ago, was built, with the exception of the motor which carries it, entirely in the workshops of the Signal Corps Laboratory at Washington.

The prime source of power is the 30 h.p. motor which hauls the van. This operates a 2 kw. Diehl generator with an output giving 110 volts at 500 cycles, which current is stepped up to 22,000 volts by a 2 kw. open-core transformer and discharged through the quenched gap mounted on the switchboard between the two seats. The normal radiation of the set is stated to be 16½ amperes.



*American Army New Field Apparatus.*

The arrangement of the plant, which may be checked on the illustration above showing the interior view of the operating car, is such that the switchboard and the instruments governing the primary current figure on the left side of the car whilst the receiving set is on the right-hand side. All the instruments likely to be affected by vibration are mounted on springs. Amongst those on the primary switchboard that are so safeguarded are a voltmeter, ammeter, frequency meter, wattmeter, field rheostat and primary relay.

A moulded mica condenser, edgewise-wound helices and loading coils are all mounted behind the switchboard and controlled by substantial handles. In the centre of the board is a hot-wire meter. The receiving set consists of a "doughnut" tuner, two variable condensers, two very simple detectors, which are stated to work to perfection, a pair of 5,000-ohm phones and the necessary switches. The crystals used are galena, cerusite, and a new substance known as "silicite."

The aerial, which is the outcome of prolonged experiments under service conditions, is of the umbrella type. It is supported

when in use for average work upon a 85-ft. mast built of sections and has been erected in ten and a half minutes. For long distance work the mast is raised to 110 ft. The earthing arrangements, as improved by experiment, consist of insulated wires radiating out in all directions from a central socket into which each wire plugs. The extreme end of each wire is firmly fastened into moist ground. In actual operation the telegraphist, after receiving his call, signals to a private to start up the motor which drives the generator. He then throws the change-over switch, and directly his meters show the plant to be running satisfactorily he starts sending. When the message is despatched the motor is stopped. The operators are proud of the fact that, although the car is violently shaken when the generator is running, the detector invariably remains in adjustment. The detectors are shunted with a 5 mf. condenser when sending.

\* \* \*

How far the most recent portable sets employed in the British Army can compete with this American "marvel" we may not speculate at this juncture. When war is over perhaps we may say things. In the meantime it is interesting to note that the application of wireless to Army purposes has so stirred the imagination of the public as to receive prominence in the Press. Half a page of pictures, for instance, appeared in the *Daily Call* on March 8th illustrating the work of the "wireless detachment" in the signalling section of the Westmoreland and Cumberland Yeomanry. Two pictures dealing with the same corps are reproduced in this issue (pp. 47 and 48).

Whilst it would be indiscreet to enter into details regarding this apparatus, reference to the Westmoreland and Cumberland Yeomanry's appliances is appropriate, for we believe that this regiment was the first cavalry unit to equip itself with a really efficient series of wireless sets at its own expense. We do not know what has happened since the outbreak of war, but we believe we are right in stating that up to August last the wireless sets owned and worked by these smart North Countrymen were regarded by the War Office as in the nature of a hobby and therefore not entitled to subsidy.

As officers and men have made the present set a common hobby, it may be taken for granted that every improvement within the limits of their ingenuity has been applied to it.

\* \* \*

During a recent visit to the Front under official guidance a party of British journalists were shown the wireless and other stations employed in the rapid and secret transmission of messages. What they saw may be recounted at the end of the war or at some time earlier when the existing situation has changed, but it may not be out of place to recall the types of station employed by the armies of the world up to two summers ago. Generally speaking, they were of Marconi pattern and could be classified as long-range stations, intermediate-range stations, cavalry stations, landing stations—the two latter being modifications of the intermediate stations and short-range stations of extreme mobility.

The largest of these had a range of about 200 miles and took eight men about ten minutes to erect. The prime mover was an eight horse-power specially air-cooled engine. The antennæ consisted of two woven wires about 500 feet long supported by two masts 70 feet high. The earth connection consisted of four strips of phosphor-bronze wire netting, each of about 90 square

feet, laid on the surface of the ground. For the erection of the mast a derrick was employed. All the refinements invented for long-range work could be used with these stations, as weight within reasonable limits played no very important part.

\* \* \*

The intermediate stations, although having a wider range of utility, lacked many of the refinements associated with the larger sets. They could be worked by fewer men, erected and dismantled in shorter periods of time, and be employed in most expeditionary works. The prime mover was a twin-cylinder engine of about  $2\frac{1}{2}$  h.p., the aerial 350 feet of wire supported on 30-ft. masts. When arranged for pack transport the engine and dynamo were mounted on either side of a rigid pack-saddle frame. By ingenious design no animal was given a load exceeding 200 lbs. This means that the whole equipment could be transported at a gallop if necessary. If required for landing purposes the apparatus was distributed so as to be divisible into loads of 75 lbs. weight. The range of these stations was usually about 50 miles, although with 70-ft. masts an increase up to 100 miles was possible.

The short-range stations, of which the "knapsack" variety was a type, were



*British Yeomanry Field Equipment.*





*British Portable Aerial.*

designed in loads of between 20 and 30 lbs. They could be carried by four men and worked effectively over 10 miles. An umbrella form of antenna was employed and primary batteries or accumulators used as the source of energy. Landing stations of the intermediate range variety are known to be included amongst the equipment of the Turkish Army.

\* \* \*

The method of securing secrecy most strongly advocated by the Marconi Wireless Telegraph Company was that of changing the wavelength of the transmitter at frequent pre-determined intervals. This was made possible by the use of a change-tune switch capable of use with both transmitter and receiver. By careful pre-arrangement almost any variant of wavelengths could be secured, and if practised with sufficient frequency tapping became a physical impossibility.

\* \* \*

As matters stand at present, there is scarcely any operation which is conducted without the use of wireless; even when our battleships are engaged in shelling the land forts of the decrepit Turkish Empire we read

in our daily papers, quite as a matter of course, that the operations are directed by wireless from aeroplanes.

\* \* \*

Some of us who take part in those informal Parliaments held daily in our "regular" railway compartments as we travel to town are not unfamiliar with the phrase "wireless lies," often uttered in a tone which appears to pour contempt not so much upon the "lies" as upon the medium from which they come. Now, nothing could possibly be further from the truth. *Wireless never lies.* What happens is that a great many unscrupulous people use this unique truth-teller for their own base purposes. A very good story has been told of Mr. Gladstone in connection with another branch of applied science. Mr. Gladstone once, in the House of Commons, laid down, with all the sententiousness natural to him, "photography cannot lie." Of course, in essence he was perfectly correct. Rays of light are correctly and *truthfully* reproduced by the sensitised plates, just as words are correctly and truthfully transmitted by the "waves" of radio-telegraphy. But one of the wags in the House of Commons proved the lying use to which photography might be put by producing, within twenty-four hours of Mr. Gladstone's pronouncement, a "faked" photograph of the G.O.M. showing the rt. hon. gentleman emerging from a Temple of Bacchus, within the purlieus of Seven Dials, in a state of jocund inebriety!

\* \* \*

In the same way, use has been made by Teutonic manipulators of wireless telegraphy: If their statements were founded on fact, German siege guns would be almost within battering distance of the Statue of Liberty in the West and of Tokio in the East. Let us, however, remind our critical readers that this is not the fault of "wireless." The serious part about the situation is that, had it not been for German appreciation of the potentialities of radio-telegraphy, and their provision, accordingly, of high-power stations, the Central European coalition would, at this moment, be entirely cut off from the rest of the world, both in the matter of intelligence and power of commercial communications. But that, as the poet says, "is another story."

# QUESTIONS AND ANSWERS

*Readers are invited to send questions on technical and general problems that arise in the course of their work or in their study to the Editor, THE WIRELESS WORLD, Marconi House, Strand, London, W.C. Such questions must be accompanied by the name and address of the writer, otherwise they will remain unanswered.*

R. G. O. (Tollington Park, London) is going to make a receiver, and wants to know how big his condensers and inductances should be.

*Answer.*—You seem to be rather muddled about the functions of the inductances and condensers. The maximum distance from which signals can be received depends not only on the efficiency of the receiving station, but on the efficiency of the transmitting station; its power and other factors and the weather conditions, bright sunshine, and darkness also play their parts. Every time you alter the number of turns in your aerial-tuning inductance you alter the wave-length and make signals stronger or weaker, according to whether you were in or out of tune before the alteration was made. The same with the condensers, whether aerial or detector. The aerial condenser should be of fairly large capacity, say, '01 mfd., and in the Instructional Article for December, 1914, you will find a formula which will give you good ground to work on. Your aerial might be very conveniently a twin wire of the lengths you state, with the wires 6 feet apart. In the February Instructional article you will find a method of arriving at the values of the wave-length, capacity, and inductance of the aerial, but for your convenience we have worked yours out. Your values are natural wave-length 322 metres, capacity '000634 mfd., inductance 45 mhs. Further in this article you will find instruction in the determination of the value of the necessary inductance to increase the wave-length of your station to the value you desire. There is also some information on the calculation of the inductance of a coil. You would do well to read carefully the articles mentioned, and also the answer to G. P. (Widnes) in the February WIRELESS WORLD. For your detector circuit you require a condenser of, say, '0004 mfd. maximum capacity. Having settled the wave-length you wish to receive, you can find the inductance from  $\lambda = 1885 \sqrt{LC}$ , and then calculate the number of turns to put on your coil. A better way to arrange your circuits is shown in the reply to C. F. (Watford, Ontario), in the March issue. This shows the arrangement of potentiometer and cells. The water pipe should make a good earth.

J. W. (West Bridgford, Nottingham) asks questions about coefficients of coupling and the measurement of same.

*Answer.*—In the article you mention, it is stated that the formula given is not exact, but a close approximation. Dr. Fleming, in his book *The Principles of Electric Wave Telegraphy and Telephony*, gives the following formula:—

$$K = \frac{\lambda_1^2 - \lambda_2^2}{\lambda_1^2 + \lambda_2^2}$$

Where  $\lambda_1$  is the longer wave emitted  
 $\lambda_2$  is the shorter wave emitted

K is the coefficient of coupling, and this coefficient is a fraction. It is necessary to multiply by 100 to give a percentage. Dr. Fleming also gives  $2 \lambda_0^2 = \lambda_1^2 + \lambda_2^2$ . Where  $\lambda_0$  is the wave-length to which both circuits are tuned separately. Taking the ship set as an example, if the primary jigger circuit and the secondary or aerial circuit are both tuned separately to a wave-length of  $\lambda_0$ , and then these two circuits are closely coupled together, two waves will be emitted  $\lambda_1$  and  $\lambda_2$ . If now a wave-meter be applied, it will be found that there are two distinct

points at which the instrument tunes. These two points being the position on the wave-meter for  $\lambda_1$  and  $\lambda_2$ . Substituting these values in the above equation and working out we have the value of K. It is wrong to suppose that the true wave-length is the mean of the two wave-lengths measured by the wave-meter. You will find in the article you mention some information of this description. If two circuits were fully coupled, the two resultant waves would be so far apart that one would be sensibly zero, and the only wave-length left would be  $\sqrt{2}$  times the wave-length to which the two circuits were tuned separately. Taking the second formula  $2 \lambda_0^2 = \lambda_1^2 + \lambda_2^2$ ; let  $\lambda_2$  be vanishingly small, then  $2 \lambda_0^2 = \lambda_1^2$  and  $\lambda_1 = \sqrt{2} \lambda_0$ . It will be seen from this formula that the square of the tuned wave-length equals the mean of the sum of the squares of the resultant wave-lengths. For your other query the best way of obtaining first-hand information is to write to some of the schools and ask for their prospectus.

"BOULANGE" enquires as to what form the voltage-distribution curve would take for the aeriels illustrated in Figs. 7 and 8 of the instructional article for the July, 1914, number, when the condensers at the base of the aerial are connected to earth by long wires.

The general form of the curve would be as follows:—

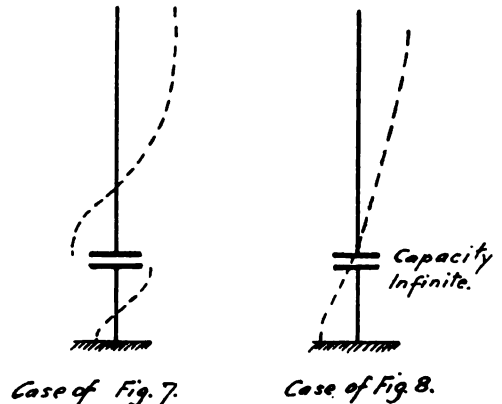

The positions of the nodes would depend on the relative lengths of aerial and earth wires and the capacity of the condenser.

"EXPERIMENTER" (Calcutta) is interested in telemechanics, and wants to use a coherer as a means to operate other apparatus. He evidently wants to arrange things so that one signal causes his remote apparatus to start working, and another signal causes some change in the working, or, perhaps, stops it. He also describes a coherer he made from a piece of glass tube with brass plugs and iron filings, but he says that this is extremely insensitive, and wants to make a more sensitive one

*Answer.*—Other people have adapted coherers to work as you suggest, and have taken out patents for their ideas, but altogether it is a rather complicated scheme, and too big to be handled in these columns. In the Marconi Company's fog-signalling apparatus there is an extremely ingenious idea, the great feature being that whilst signals sent at any irregular periods, such as ordinary Morse signals, will not affect the receiver, special signals sent at a certain frequency cause relays to operate and shut switches, and other signals sent at another frequency again work the relays and cause the switches to open. This apparatus was described in *THE WIRELESS WORLD* for June, 1914, and there was another article in the July number dealing with telemechanical problems. The study of these articles will, perhaps, give you an idea of the lines to work on, and it is always possible to get Patent Specifications describing previous ideas. Your coherer is, perhaps, rather roughly made and could be very well exchanged for a Marconi one. This doubtless would be much more sensitive than a home-made one.

A. J. A. (St. Albans, Herts) asks if he can use a coherer and bell instead of a telephone in his circuit; he also sends a sketch of his coherer.

*Answer.*—The coherer you propose to use is a form of one known as the Italian Navy coherer; but why use a coherer at all? To do such a thing for ordinary reception is certainly a step backwards. The first wireless stations were fitted with coherers, but as time went on these things gave place to more sensitive apparatus, and to-day the crystal and telephone combination holds its own in most cases against all comers. If you do use the carbon-mercury coherer in the manner you suggest, you will find it as well to use a very light vibratory apparatus, such as a high note buzzer, but we do not think you will get any satisfaction from your set, as the coherer you show easily gets out of order, is very liable to jamming, and you will not be able to distinguish one station from another by their respective notes. You will also find that you want a much higher voltage to work your buzzer in this manner than if you were working a buzzer in the ordinary way. Look up some of the back numbers of *THE WIRELESS WORLD*, and you will see advertisements for telephones which will be suitable in every way for your work.

## THE APPLICATION OF WIRELESS TELEGRAPHY TO SMALL CRAFT.

**T**HE problem of the equipment of small vessels with wireless telegraphy is one which has been receiving considerable attention from experts recently.

The main difficulty which confronts the designer of apparatus for this purpose is the restricted space available for carrying the antennæ wires. As is well known, a considerable length of aerial is required to obtain the utmost efficiency, and where the maximum aerial span has to be brought within the limits of a small vessel having, say, a total length of only 36 feet, the efficiency of the wireless equipment is seriously reduced. The same problem, of

course, arises in the design of wireless apparatus for aeroplanes, where the length of the aerial wires must be brought within the limits of the maximum length of the machine from the front of the upper plane to the tip of the tail.

No doubt there have been many private experimenters who have fitted small power wireless sets of their own design to private motor boats and sailing boats, but, so far, the application of wireless to such small craft has not extended very far in commercial use. The reason for this may perhaps be traced to the fact that small craft would seldom have cause to employ wireless telegraphy, since their business would not usually require that they should be capable of inter-communication, or of communication with a base.

Not long ago, however, a new channel was opened up for the use of wireless on small craft. This was in the equipment of the motor lifeboats of the s.s. *Aquitania* with wireless apparatus. The equipment of this type of vessel was the result of a recommendation made by the Committee for the Safety of Life at Sea, and the object in view was to enable the motor lifeboats to keep in touch with one another in the event of disaster or mishap to the mother ship, and also to enable them to signal for assistance to passing vessels. The apparatus fitted to these lifeboats was designed by the Marconi Company and is capable of receiving on wave-lengths up to 600 metres and will transmit on a 300 metre wave-length. A description of this apparatus was given in the issue of June last of this magazine.

Three years ago a  $\frac{1}{2}$ -kw. Marconi set was fitted to a Swedish motor boat attached to a fleet of fishing vessels. The motor-boat was able to communicate with the coast station at Gothenburg when the fishing fleet was thirty miles out at sea. This example forms a striking illustration of the adaptability of wireless to small vessels of this description.

From the foregoing remarks regarding the reliability of the service of wireless telegraphy when applied to small craft, it would seem that a new and important use might be made of small motor-boats fitted with wireless telegraphy and capable of travelling at a high speed. Such craft

it would seem, might be used to advantage for the purpose of patrolling a coast in time of war on the look-out for any signs of hostile submarines or of the approach of raiding warships. Many vessels of this type could be built in the same time and at the same cost as one torpedo boat or torpedo boat destroyer, and, owing to the small size of the vessels, they would run but little risk of being torpedoed by hostile submarines, and would be able to communicate instantly with any ship or coast wireless station within a radius of, say, fifty miles, should any hostile craft be sighted. For the purpose of repelling submarine attacks these small craft might also be armed with a small quick-firing gun.



*Swedish Motor-Boat fitted with Wireless.*

## SIGNAL SERVICE 1st LONDON DIVISIONAL ENGINEERS.

MAJOR GORDON RENNARD, R.E. (T.), has written to us asking us to draw attention in our columns to the following notice regarding the Third Signal Company of the Royal Engineers (Territorial Force), which is about to be raised. We have very much pleasure in acceding to his request.

“A third Signal Company will shortly be raised. Applications are required for enlistment from young, well-educated electrical engineers or electrical engineering students. Applicants should possess a practical working knowledge of some branch of the electrical industry, or have studied at some technical institute.

“The work of the Company being of a highly technical nature, the experience gained after some months' service renders a man more qualified for appointments in civil life.

“Most of the men are mounted, but those unable to ride will be taught.

“The pay and allowances are at the special Royal Engineer rates, with separation allowance to dependants.

“Applications for enlistment should be made, in the first place in writing, to the Recruiting Officer, c/o O.C. 2/1 London Divisional Signal Company, 10 Victoria Park Square, Bethnal Green, E.”

# INSTRUCTION IN WIRELESS TELEGRAPHY

(Second Course)

## (IX.) The Receiving Circuit.

[The dislocation of our arrangements, due to the war, has prevented us from completing, in our last Volume, the second course of Instructional Articles. These are being continued in the third Volume, and we hope to arrange for the Examination (full particulars of which are given on page 333 of our issue of August, 1914) to be held in the early autumn of this year. The present is the ninth of the second series of articles, which will deal chiefly with the application of the principles of wireless telegraphy. Those who have not studied the first series are advised to obtain a copy of *The Elementary Principles of Wireless Telegraphy*, which is now published, price one shilling net, and to master its contents before taking up the second course of instruction.]

THE descriptions of the four types of receivers, printed on pages 801 to 805 of our March issue, were not affixed to the figures.

They should be read as follows:—

Fig. 1 is that of Receiver, type 3.

Fig. 2 is that of Receiver, type 4.

Fig. 3 is that of Receiver, type 1.

Fig. 4 is that of Receiver, type 2.

**748.** The fifth class of receivers consists of those in which the aerial and detector circuits are coupled by one (or more) intermediate circuits.

The presence of this intermediate circuit does not alter the design of either of the other two circuits; in fact, receivers using this arrangement are often made so that the intermediate circuit may be cut out by a switch if desired.

The intermediate circuit consists of two inductances, one of which couples with the aerial and the other with the detector circuit, with a tuning condenser, which may be either in series or in parallel with the two coils.

In the latter case the two coils must be of exactly the same inductance, but if the condenser be in series the coils may be of different dimensions to suit the coils to which they are linked.

When in parallel the total inductance of the circuit will be half that of one coil, so that to design an intermediate circuit to receive a given wave-length with the coils in parallel each coil must have twice the value of inductance required by the formula  $\lambda_m = 1885 \sqrt{LC}$ .

When in series the total inductance is the sum of that of the separate coils, and hence they are made so that this sum gives the calculated value for the wave-length.

The object of the intermediate circuit

is to increase the selectivity of the receiver for the signals required. This circuit being tuned to the same wave-length as that of the signals, the current in the aerial circuit produced by the signals gives a larger current in the intermediate circuit than would equal currents in the aerial which are of different wave-lengths.

This effect also occurs between the intermediate and detector circuits, so that the signals undergo a double "sifting" before they affect the detector.

The intermediate circuit to be of any real use must have a low resistance, so that its use will not introduce extra damping in the signals received.

The inductance is therefore small with a relatively large condenser; for instance, one with a maximum capacity of .01 mfd may be used.

The full value of this circuit can only be obtained when the coupling and tuning of the various circuits are carefully adjusted.

**749.** If two circuits, both of which have been tuned to the same wave-length separately, be placed close together and oscillations set up in one of them, then in general two wave-lengths will be found to exist in the combined circuit. One of these will be greater and the other less than the wave-length to which the circuits were separately tuned, and this difference will increase as the two circuits are brought close together.

They are said to be tightly coupled, and if  $\lambda_1$  and  $\lambda_2$  be the two wave-lengths, the ratio  $\frac{\lambda_1^2 - \lambda_2^2}{\lambda_1^2 + \lambda_2^2}$  is termed the co-efficient of coupling between them.

The coupling between the two circuits may be either electromagnetic or electrostatic, or both.

If the two circuits be coupled electro-

magnetically, then the coefficient of coupling for any arrangement can be calculated from the mutual inductance between the circuits for the given relative positions of their inductances and the value of self-inductance of these coils.

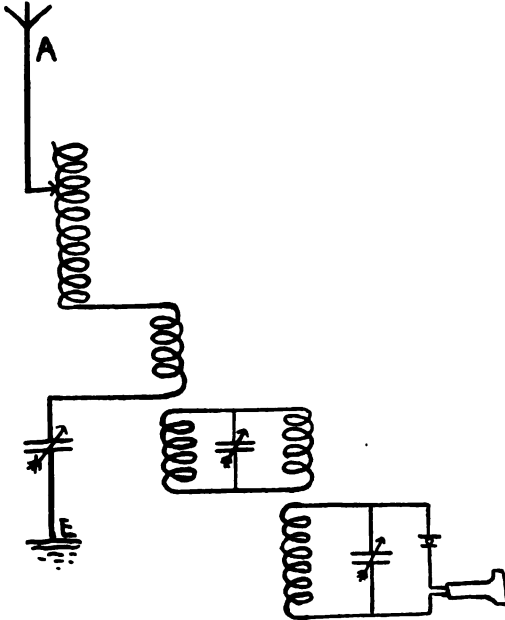

Receiver—Type 5.

The ratio  $\frac{M}{\sqrt{L_1 L_2}}$  where  $M$ =mutual inductance between the circuits  $L_1$  and  $L_2$ =self-inductances of the whole of the coils associated with each circuit, is the co-efficient of coupling between the two circuits.

If the circuits be coupled electrostatically the co-efficient of coupling is  $\frac{\sqrt{C_1 C_2}}{K}$  where  $K$ =mutual capacity between the circuits, and  $C_1$  and  $C_2$  the capacities of the two circuits. Receivers using pure electrostatic coupling are almost unknown, although various transmitting circuits employing electrostatic coupling have been designed.

Most receivers which are designed for electromagnetic coupling have a certain amount of electrostatic coupling as well; since two coils of wire placed close together will form the two plates of a condenser just as two metal cylinders will, and the circuits are coupled by this mutual capacity.

If, as in some receivers, the primary coil slides right inside the secondary, the electrostatic coupling between the circuits may be quite large.

750. When the two circuits are coupled both electromagnetically and electrostatically the coefficient of coupling between them depends on whether the two couplings are so as to assist or oppose each other.

In an article in THE WIRELESS WORLD for July, 1914, Mr. Pletts has worked out the coupling for such a case, and shows that if  $m$  be the electromagnetic and  $s$  the electrostatic coupling between the circuits,  $k$ , the coefficient of coupling between them which corresponds to that given by the two

$$\text{wave-lengths is } k = \pm \frac{m \pm s}{1 \pm ms}$$

It is also shown in the article that, from this equation, if either the electrostatic or electromagnetic coupling be tight, then, however loose the other may be, the resultant will be tight, and if neither be tight then the resultant will not be tight.

It is useful, therefore, to be able to calculate the maximum and minimum coupling which will be given by any receiver. For pure electromagnetic coupling we must know the total inductances of the two circuits—i.e., not merely of the two coils by which they are coupled but of all the coils in the circuits. In most cases the inductance of the aerial and any straight leading-in wires is relatively small, and if so may be neglected.

The inductances may be worked out by the formulas already given.

We also require the mutual inductance between the circuits. This can be calculated from the dimensions and distance apart of the two coupling coils. It is not possible to give a formula, since the best one to use depends on whether the coils are close together, or far apart, etc. In a subsequent article we hope to give a table or curve by which the calculations may be facilitated.

It is important, however, to design a receiver so that the coupling can be made loose if required, since the ability to tune-out interfering signals depends largely on a proper adjustment of the coupling—a point which is often overlooked.

There is no reason why the whole of the aerial tuning inductance should not be used

to couple to the detector inductance provided it can be placed at a sufficient distance away to ensure weak coupling. For a compact receiver, however, it is usually better to use a separate coupling coil with an inductance such that it gives a good degree of coupling when the receiving circuits are tuned to the longest wave-length which is to be received.

A coupling of 10 per cent—*i.e.*, for which  $\frac{M}{\sqrt{L_1 L_2}} = 0.1$ , is quite strong enough for most purposes.

Receivers which do not permit a variation in coupling, such as those of Class II., cannot give such good all-round results as those which allow of an adjustment.

**751.** It is important to note that an idle coil of wire may reduce the strength of signals in a circuit near which it may be placed. As mentioned above, every coil has a distributed capacity which forms with it a circuit in which alternating current can flow. If the natural wave-length of the coil be near that of the circuit the amount of energy which it can absorb from it depends on the coupling between them. If the coils have a large mutual inductance the energy absorbed will be great.

In order for a receiver to be able to receive both long and short waves it is necessary to divide the secondary inductance into several sections, since, as has been pointed out above, it is not possible to use a very large capacity in the tuning condenser for the purpose. There are several methods by which this may be done :

(1) The inductance can be wound in a single continuous winding on a tube with tappings made at suitable intervals brought out to terminals or switch contacts.

(2) The winding can be in several distinct sections, separated by spaces, on the same tube, which are put in series for long waves by special switches.

(3) The coils can be wound on separate formers, which are either each sufficient for a special wave range or may be connected in series with leads.

This last method provides that the idle coils have no influence on the working ones, but it is not possible to make quick changes from one wave-range to another, which is sometimes desirable.

The first method allows change of wave-length to be quickly carried out, but the coupling between idle and active coils is as strong as possible. It should, therefore, not be adopted where the natural wave of the idle coil is as great as any to be received on the lower ranges. In this connection the fact that the natural wave is a harmonic of the other is nearly as detrimental as if it is the same. This method of connection will, in practice, be found to be unsuitable for coils of large inductance.

The second method is a compromise between the others, and by skilful adjustment of the inductance and mutual inductance values an efficient receiver may be constructed on this principle, with the advantage that it can quickly be set to any wave-length. It is to be noted that although mutual inductance is detrimental when it allows energy to be absorbed by idle coils, it is advantageous in that by combining two coils to form an inductance the value of inductance obtained is  $L_1 + L_2 + M$ , where  $L_1$  and  $L_2$  are the self-inductances of the coils, and  $M$  the mutual inductance between them. This means that  $L_2$  has less resistance and costs less for wire than if its value was simply added to that of  $L_1$ , as it would be if they were connected at right angles to one another.

**752.** The principal parts of the receiver have now been dealt with. Before proceeding to consider the actual detector and such instruments as the telephones, etc., used in connection with it, we will first touch upon one or two minor points connected with the receiver and then proceed to some calculations of the various circuits.

It is well known that there exists a difference of potential between the surface of the earth and the atmosphere at different levels above it. The gradient of this potential difference varies from time to time and becomes very great at times, as when a thunderstorm is approaching.

Due to this potential difference a current will flow in any conducting body, such as an aerial, which runs from the earth to any considerable height in the atmosphere.

This current is unidirectional and will not affect the detector if the latter be associated with a coupled secondary circuit.



If the detector circuit be direct-coupled to the aerial some of this current may flow through the detector, and this, as will be shown in the article on detectors, may modify its sensitivity.

A detector, such as a thermogalvanometer, placed directly in the aerial circuit will, of course, indicate the total current flowing through it, which includes this "static" current.

If, however, we are using a condenser in series with the aerial this unidirectional current will be checked and the condenser will be charged to a voltage which will vary from time to time, but which in general will be considerable and may easily reach a value sufficient to puncture the thin dielectric sheets of which the condenser is often constructed. To prevent this a coil with a very large inductance is connected in shunt with the condenser. The coil may be wound with fine wire, since the resistance (within reasonable limits) is not of importance, merely reducing the steady current flowing, but its inductance must be several times larger than that of any other part of the circuit, so that the oscillations due to the signals will pass through the condenser and not through the inductive winding.

This coil is usually called a static coil, as its function is to prevent a "static" charge accumulating in the condenser.

If the potential gradient varies rapidly, as often happens, the inductance will not be sufficient to protect the condenser, since it offers an obstruction to sudden variations in the current passing through it.

For this reason, and also to protect the condenser from strong "atmospherics," a spark gap should be connected to the two plates of the condenser.

It is advisable to connect another spark-gap across the aerial and earth terminals of the receiver to protect the inductance and condenser as a whole against strong atmospheric disturbances.

When the secondary coil is of large inductance it is as well to protect this circuit by a spark-gap across the condenser in the same way.

Care must be taken to keep all these gaps clean, as the smallest particle of dirt between them or even a film of moisture will weaken or cut off signals in a manner which will puzzle the careless experimenter.

We will next consider some calculations of various parts of the circuits which make up a receiving instrument.

## PANAMA-PACIFIC EXHIBITION

*Formal Opening Ceremony Performed by Wireless from Washington.*

WE can most of us remember writing copy-book maxims at school. One of the favourite exercises of our writing master laid it down that "Peace hath her victories no less renowned than war." It is owing to present circumstances, and the world-wide character of military operations, that we are continually referring to instances of the utility of radio-telegraphy in *warfare*. It is pleasant to turn for a moment to the more peaceful side of our existence and call attention to an occasion of a notable triumph of peace and wireless telegraphy. The commencement of working the Panama Canal has been fitly followed up by the opening of the Panama-Pacific Exhibition. President Wilson, with his numerous engagements, might have found it difficult to go down to the Isthmus in order to perform the opening ceremony; so wireless came to the rescue. At three o'clock, Washington time, on February 20th, the President of the United States closed a key, which sent a wireless signal, operating automatically, through the antennæ on the Tower of Jewels, in the exhibition grounds, and throwing open the Exhibition to the public. At the instant it was received the doors swung open, and the Mayor of San Francisco, heading a delegation of citizens, entered the Exhibition, the fountains began playing, and the wheels of the machinery turned. In sending the signal which officially opened the Exhibition, the President used a telegraph key studded with gold nuggets, which was used by President Taft in opening the Alaska-Yukon Exhibition. Several distinguished government officials were present at the ceremony.

The Exhibition Company, the various States and nations and the concessionaires, have vested approximately \$80,000,000 in buildings and work done. Including the value of the exhibits, it is estimated the Exhibition represents an investment of \$300,000,000 or more.

# The LIBRARY TABLE



AIRCRAFT IN WAR. By J. M. Spaight, LL.D.  
London: Macmillan & Co.

Dr. J. M. Spaight in his *Aircraft in War*, a book evidently written before the cataclysm of August last, insists, as Major Baden-Powell insisted ten years ago, that the advent of mechanical flight requires a modification of the Legal Code and even of International Laws. Dr. Spaight has anticipated this development by sketching out a code for aircraft in war, and by placing this code alongside similar proposals by eminent legal authorities in other countries. We can only hope that the time is quite near at hand when affairs of so international a character can be discussed in a manner that is fitting.

The volume, it may be emphasised, has points of direct appeal to the student of "wireless." Dr. Spaight is particularly well informed in all matters relating to the progress of aviation, and, as might be expected under the circumstances, makes allusion to the use of wireless upon aircraft. In advocating the sequestration of private enemy aircraft in a belligerent's territory at the outbreak of war, he points out that every aircraft that can fly can be employed in war to some useful purpose, such, for instance, as the transmission of information by wireless telegraphy. In support of his argument he points out that wireless installations shown at the Paris Exhibition of 1913 and Olympia, 1914, were said to have a range of 120 and 110 miles respectively. "Seaplanes had actually sent wireless messages over 100 miles, and land aeroplanes over 50."

In suggesting regulations for controlling the use (by belligerent military aircraft) of wireless telegraphy stations erected on neutral territory, Dr. Spaight holds that the provisions of Articles 3, 8 and 9 of the Hague Convention on the Rights and Duties of Neutral Powers and Persons in Land War, and of Article 5 of the Hague Convention on the Rights and Duties of Neutral Powers in Maritime War, are applicable. For the information of any who may be interested, these articles were reproduced upon page 450 of the last volume of *THE WIRELESS WORLD*.

Leaving the "wireless interest," some excuse may be offered for reproducing Dr. Spaight's views on the possibility of an aerial bombardment of London. The author points out that history produces cases in which undefended cities have been grievously damaged by shells directed against Government stores therein. "International Law," he says, "enjoins the respect for the lives and property of pacific citizens in war time, but it recognises that non-combatants may have to suffer when they or their property are unlucky enough to be near a scene of operations or military stores and plant which the enemy has a clear right to destroy." "Still," he adds, "when all is said, to bombard a city like London from the air would undoubtedly be an extreme and unprecedented act of belligerency."

How strangely prophetic! London has not yet been bombarded, but since this book was written bombs have fallen on the peaceful villages of Norfolk and the fortified places of Kent.

# The Wireless Transmission of Photographs.

By MARCUS J. MARTIN.

## ARTICLE I.

**I**N THE WIRELESS WORLD, Vol. 2, Nos. 22, 23, 24, the manner in which photographs and drawings are prepared and transmitted by the aid of "wireless" has been fully explained, and in this series of articles the several available methods of receiving, and the driving and synchronising of the two stations, will be dealt with. Before, however, going on to describe the various methods of receiving, the following points in connection with the transmitting apparatus will be first considered.

It was assumed in Article 3 (WIRELESS WORLD, No. 24) that the number of contacts made by the stylus is 5,000 per minute, and in working at this speed the first difficulty is encountered in the use of the two relays. The relay R is lightly built and capable of working at a fairly high speed, but R<sup>1</sup> is a heavier pattern, and consequently works at a slightly lower rate. This relay must necessarily be heavier as more substantial contacts are needed in order to pass the heavy current taken by the spark coil. Relays sensitive and accurate enough to work at this speed will in all probability be beyond the reach of the majority of workers, but there are several types of relays on the market, very reasonable in price, that will answer very well for experimental work,

although the speed of working will, no doubt, be slower.

For the best results the duration of the wave-trains sent out should be of the same duration as the contact made by R, and therefore equal to the time taken by the stylus to trace over a conducting strip; but if the duration of the contact made by R is  $t$ , then that made by R<sup>1</sup> and consequently the duration of the groups of wave-trains would be  $t-v$ , where  $v$  equals the extra time required by R<sup>1</sup> to complete its local circuit. The difference in time made by the two relays, although very slight, will be found to affect the quality of the received pictures. Renewing the platinum contacts is also a great expense, as they are soon burnt out where a heavy current is passed.

If the distance experimented over is short so that the power taken by the coil is not very heavy, one relay will be sufficient, providing the contacts are massive enough to carry the current safely. It is useless to expect any of the ordinary relays in general use to work satisfactorily at such a high speed, and in order to compensate for this we must either increase the time of transmission or, as already suggested, make use of a coarser line screen in preparing the photographs. For reasons already explained all points of make and break should be shunted by a condenser. The effective working speed of an ordinary type of relay may be anything from 1,000 to 2,500 per minute, depending upon accuracy of design and construction.

In the wireless transmission of photographs it is absolutely essential to use some form of rotary spark gap, as where sparks are passed in rapid succession the ordinary type of gap is worse than useless. When a spark passes between the electrodes of an ordinary spark gap, Fig. 17, we find that for a fraction of a second after the first spark has passed the normally high resistance of

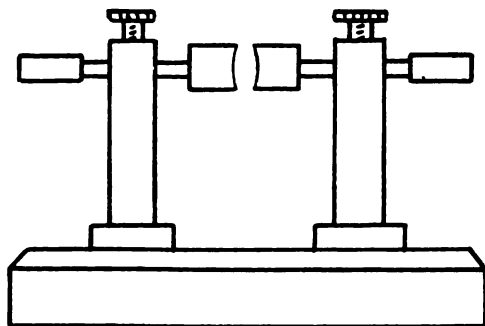

Fig. 17.

the gap has been lowered to less than 1 ohm. If the column of hot gas which constitutes the spark is not instantly dispersed but remains between the electrodes, it will provide an easy path for any further discharges, and if sparks are passed at all rapidly, what was at first a disruptive and oscillatory discharge will degenerate into a hot, non-oscillatory arc.\*

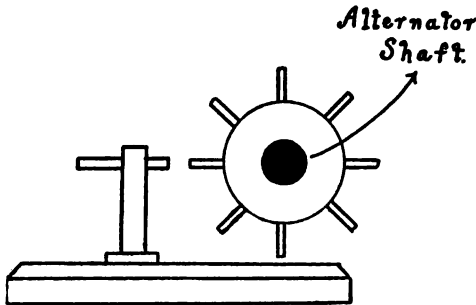

Fig. 18.

Two forms of rotating spark gaps are shown in Figs. 18 and 19, and are known as "synchronous" and "non-synchronous" gaps respectively. In the synchronous gap the cog wheel is mounted upon the shaft of the alternator, and a cog comes opposite the fixed electrode when the maximum of potential is reached in the condenser, thus ensuring a discharge at every alternation of current. With this type of gap a spark of pure tone is obtained, which is of great value where the signals are received by means of a telephone, but where the signals are to be mechanically recorded the tone of the spark is of little consequence. In a non-synchronous gap a separate motor is used for driving the toothed wheel, and can either be mounted on the motor shaft or driven by means of a band, there being no regard given to synchronism with the alternator. The fixed electrode is best made long enough to cover about two of the teeth, as this ensures regular sparking and a uniform sparking distance; the spark length is double the length of the spark gap. The toothed wheel should revolve at a high speed, anything from 5,000 to 8,000 revolutions per minute, or even more being required. The shaft of the toothed wheel is preferably mounted in ball bearings.

\* In wireless telegraphy "arcing" is principally caused by the continuation of the energy supply after the aerial has been charged to a potential sufficient to break down the insulation of the gap.

Owing to the large number of sparks that are required per minute in order to transmit a photograph at even an ordinary speed it is necessary that the contact breaker be capable of working at a very high speed indeed. The best break to use is what is known as a "mercury jet" interrupter, the frequency of the interruptions being in some cases as high as 70,000 per second. No description of these breaks will be given as the working of them is generally well understood.

In some cases an alternator is used in place of the battery, B, Fig. 16, and when this is done the break, N, can be dispensed with. In larger stations the coil, H, is replaced with a special transformer.

The writer has designed an improved relay which will respond to currents lasting only  $\frac{1}{100}$ th part of a second, and capable of dealing with rather large currents in the local circuit. This relay has not yet been tried, but if it is successful the two relays, R and R', can be dispensed with, and the result will be more effective and accurate transmission.

The connections for a complete experimental station, transmitting and receiving apparatus combined, is given in Fig. 19a. The terminals, W, W, are for connecting to the photo-telegraphic receiving apparatus.

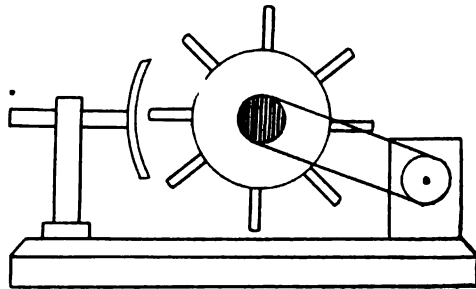

Fig. 19.

Q is a double-pole two-way switch, for throwing either the transmitting or receiving apparatus in circuit.

There is another system of transmitting devised by Prof. Korn, which employs an entirely new method from the foregoing. By using the apparatus just described the waves generated are what are known as "damped waves," and by using these damped waves, tuning, which is so essential to good commercial working, can be made to

**Map of the Wireless Stations of the World**

(Revised March 1915) can be supplied separately, in flat form suitable for framing. Printed in 3 Colours. Size of Map 34 in. by 22 in. Price 1/6 net. Postage 2d.

**Test Questions on Wireless Telegraphy.**

Series 1. The Elementary Principles of Wireless Telegraphy.  
Series 1a. Book of Model Answers.  
Price 1/- each.  
Postage 2d.

TO BE PUBLISHED THIS MONTH.

**The Year-Book of Wireless Telegraphy & Telephony 1915**

This important work of Reference contains :—

A unique collection of all the Laws and Regulations relating to Wireless Telegraphy throughout the World.

A complete Alphabetical List of Land and Ship Stations with their call letters.

A Glossary of Technical Terms printed in Five Languages.

Map of the Wireless Stations of the World. (Revised March, 1915.)

International Time Signal Regulations.

Together with a vast amount of exclusive information upon technical subjects.

PRICE **3/6** NET

Postage: United Kingdom, 6d. extra; Abroad, 1s. 4d.

**The WIRELESS PRESS, Ltd.**  
MARCONI HOUSE, STRAND, LONDON, W.C.

**A Useful Card for Amateurs and Learners is the Morse Code Card**

showing the Alphabet, Numerals, Abbreviations, etc., at a glance.

Price 2d. post free.

**Test Questions on Wireless Telegraphy.**

Series 2. Elementary Electricity and Magnetism (Elementary and Advanced). The P.M.G.'s Examination, and practical questions on use of apparatus.  
Series 2a. Book of Model Answers.  
Price 1/- each.  
Postage 2d.

# HARVEYS'

**17 London Street**  
 (Facing Fenchurch Street Station)  
**LONDON, E.C.**  
 TELEPHONE—AVENUE 2200.

*Business hours, 8.30—7.30.*  
*Saturdays, 1.30.*

Book to Mark Lane or Fenchurch Street Stations.

**TAILORS, OUTFITTERS,  
 BOOT & TRUNK MAKERS**

## SPECIAL PRICES

FOR

**SENIOR OR JUNIOR OPERATORS.**

- Uniform Serge Suit, complete, gold lace and buttons ... 50/-
- Uniform Serge Suit, fine quality complete, gold lace and buttons ... 60/-
- Superfine Cloth Uniform, gold lace and buttons ... 70/-
- Superfine Cloth Mess Suit, gold lace and buttons ... 65/-
- Bridge Coat, gold shoulder straps and buttons, complete ... 55/-
- Naval Cloth Cap, Badge and Band ... 7/-
- Senior gold lace Cuffs ... 7/-
- "    "    Epaulettes ... 4/-
- Junior Epaulettes ... 3/-
- Badges ... 3/-
- Crown Badges ... 4/-
- Buttons, large ... per doz. 2/-
- "    small ... 1/-
- White Suits ... 8/-, 10/6, 12/6

**WE HOLD THE LARGEST STOCK OF WHITE SUITS IN LONDON.**

A splendid selection of Fancy Suitings, Harris and Donegal Tweeds, Rain-proofs and Waterproofs always in stock.

We allow a special discount to Marconi employees on all civilian clothing of 10%

Send for our List and Patterns.

Special Orders in 24 hours.

# HARVEYS'



UNIFORM SUIT



BRIDGE COAT



MESS SUIT



PATROL SUIT

**NOTE NEW ADDRESS: Facing Fenchurch Street Station.**  
**ACKNOWLEDGED TO BE THE BEST HOUSE FOR THE WIRELESS OPERATOR.**





to one side. The manner in which the string galvanometer is arranged to reproduce the transmitted picture is shown in Fig. 27.

The connections adopted by the Poulsen Company for photographically receiving

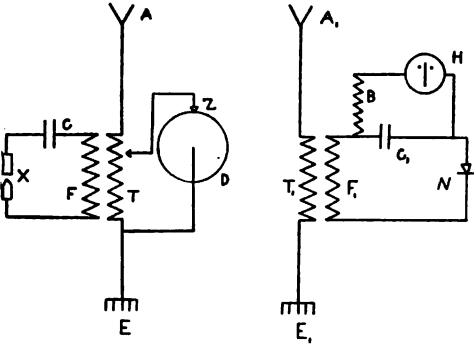

Fig. 20.

wireless messages are shown in Fig. 21, a string galvanometer of the Einthoven type being used.

The two self-induction coils, S and S<sup>1</sup>, are in circuit with the detector, D, and the galvanometer, G. The condenser, C<sup>1</sup>, prevents the continuous current produced by the detector from flowing through the high-frequency circuit. P is the primary of the aerial inductance, and F the secondary.

The method of transmitting adopted by Prof. Korn appears to be a simple and reliable arrangement, provided that an equally reliable method of producing the undamped waves can be found. Owing to the absence of mechanical inertia it should be capable of working at a good speed, while the absence of a number of delicate pieces of apparatus, all requiring careful adjustment, add greatly to its reliability. In any spark system with a properly designed aerial, a coil taking 10 amperes is capable of transmitting signals over a distance of 30 to 50 miles, but where the number of interruptions per second required is very high, as in radio-photography, it must be remembered that a much higher voltage is needed to drive the requisite amount of current through the primary winding of the coil than would be the case if the interruptions were slower. It is possible to use platinum contacts for the relays for currents up to 10 amperes, but for heavier currents than this some arrangement whereby contact is made with mercury will be found more economical and reliable.

In the transmitter already described and

given in Fig. 16, the best results would be obtained by finding the speed at which the relay, R<sup>1</sup>, works best and regulating the number of contacts made by the stylus accordingly.

The method employed by De 'Bernochi (see Article 1) of varying the intensity of a beam of light by passing it through a photographic film, which in turn alters the resistance of a selenium cell, has been very successfully employed in at least one system of photo-telegraphy. Its application has also been suggested for wireless transmission, and although with any system using continuous waves this would not be very difficult, it could hardly be adopted to work with the ordinary spark systems. The apparatus for receiving from this type of transmitter would on the other hand necessarily be more elaborate than the methods of receiving, which will be described in the next article, and so far as the writer's experience goes, experiments along these lines would not prove very profitable, as simplicity is the key-note of success in any radio-photographic system.

There can be no doubt that a system of radio-photography, if fairly reliable and capable of working over a distance of, say, 30 miles would be of great military use for transmitting maps and written matter, with a great saving of time, and even life. Written matter could be transmitted with even greater safety than messages which are sent

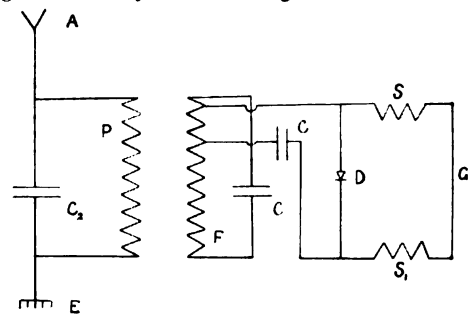

Fig. 21.

in the ordinary way in Morse code as the signals received in the receiver of a hostile installation would be but a meaningless jumble of sound, and even were they possessed of radio-photographic apparatus, the received message would be unintelligible unless they knew the exact speed at which the machines were running and could synchronise accurately.



# THE WORLD AT YOUR FEET

The Profession of a Wireless Operator is unquestionably one of the best. It is healthy, remunerative, and particularly applicable to all young men who are desirous of seeing the world. The prospects of advancement are also extremely good.

This old-established School is fitted with standard 1½ K.W. and other Marconi Wireless Sets. It is entirely controlled by experienced Telegraph and Wireless Experts, and is recognised by the Marconi and other Telegraph Companies.

## The BRITISH SCHOOL of TELEGRAPHY, Ltd.

179 Clapham Road, London, S.W.  
Telephone No. . . . . 215 BRIXTON

### "WIRELESS" and "SUBMARINE CABLE" APPOINTMENTS AT IRELAND'S PREMIER COLLEGE.

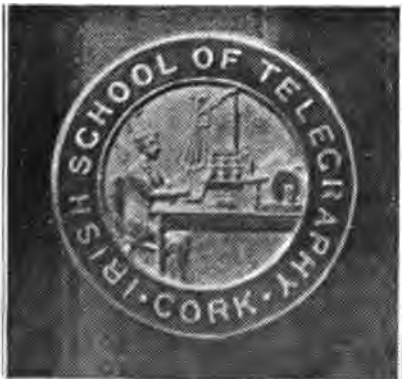

#### UNPARALLELED SUCCESSES.

A number of lucrative positions secured by our students in Wireless and Cable Companies after a short period of Training.

Principal: Mr. T. O'SULLIVAN (late Commercial Cable Company) one of the best-known expert operators in the Telegraph World. . . . Day and Night Classes. P.M.G. Examinations held in College. Young men (ages 15 to 24) should lose no time in joining.

Full particulars on application to—

THE PRINCIPAL, 18 DYKE PARADE, CORK.

## ROYAL NAVAL DIVISION

### Public School Battalion

THE ADMIRALTY have given official permission for raising a Battalion of 1,000 men, which will be strictly limited to Public School or University Men and who will serve together as a Unit.

Training is now going forward.

Applicants desiring to enrol should apply at once to

### ROYAL NAVAL DIVISION

6, 7, 8 OLD BOND STREET,  
LONDON, W.

Telephone . . . . . REGENT 5515.

**GOD SAVE THE KING.**



**WIRELESS  
OPERATORS'  
OUTFITS  
AT  
SHORT NOTICE**

**SPECIAL OFFER :**

Guaranteed Indigo  
Serge Uniform Suit  
**50s.**

Complete with Gold  
Lace and Buttons.

*Write for Pattern*  
**8562**

**BRYMAN**

5 Stockwell Road S.W.  
Opposite Stockwell Station.

'Phone: BRIXTON 780.

HOURS: 9 to 9. Wed. 1. Sat. 9.

**WIRELESS**

**The NORTH-EASTERN SCHOOLS  
OF WIRELESS TELEGRAPHY.**

**LEEDS**      **NEWCASTLE-on-TYNE**  
22 Blenheim Ter.      18 Eldon Square.

**WEST HARTLEPOOL**  
11 Church Street.

**T**HESE are the only Schools in the British Isles fitted with complete Standard Marconi, Telefunken and Poulsen Installations.

Day and Evening Classes. Complete Course for the Postmaster-General's First Class Certificate. At two recent Examinations 100 per cent. of our Day Students obtained the Postmaster-General's FIRST-CLASS Certificate of Proficiency in various systems.

A Correspondence Course can be taken by those residing too far away from any of the above Schools. This Course is both theoretical and practical, students being taught by experts.

**WRITE NOW for Illustrated Booklet.**

(H.S.)



**WIRELESS  
IN THE FUTURE**

will not be less attractive and will not offer less scope for ambition than Wireless in the past. You can find your opportunity if you enter the profession fully equipped with the best modern knowledge. A sound, practical correspondence course will so equip you without any excessive claim on your time and without serious interference with your present work.

**THE EMPIRE  
CORRESPONDENCE COLLEGE**

offers you such a course—a course of instruction broadly conceived and conscientiously carried out.

Dept. K., 143/9 Great Portland St.,  
London, W.

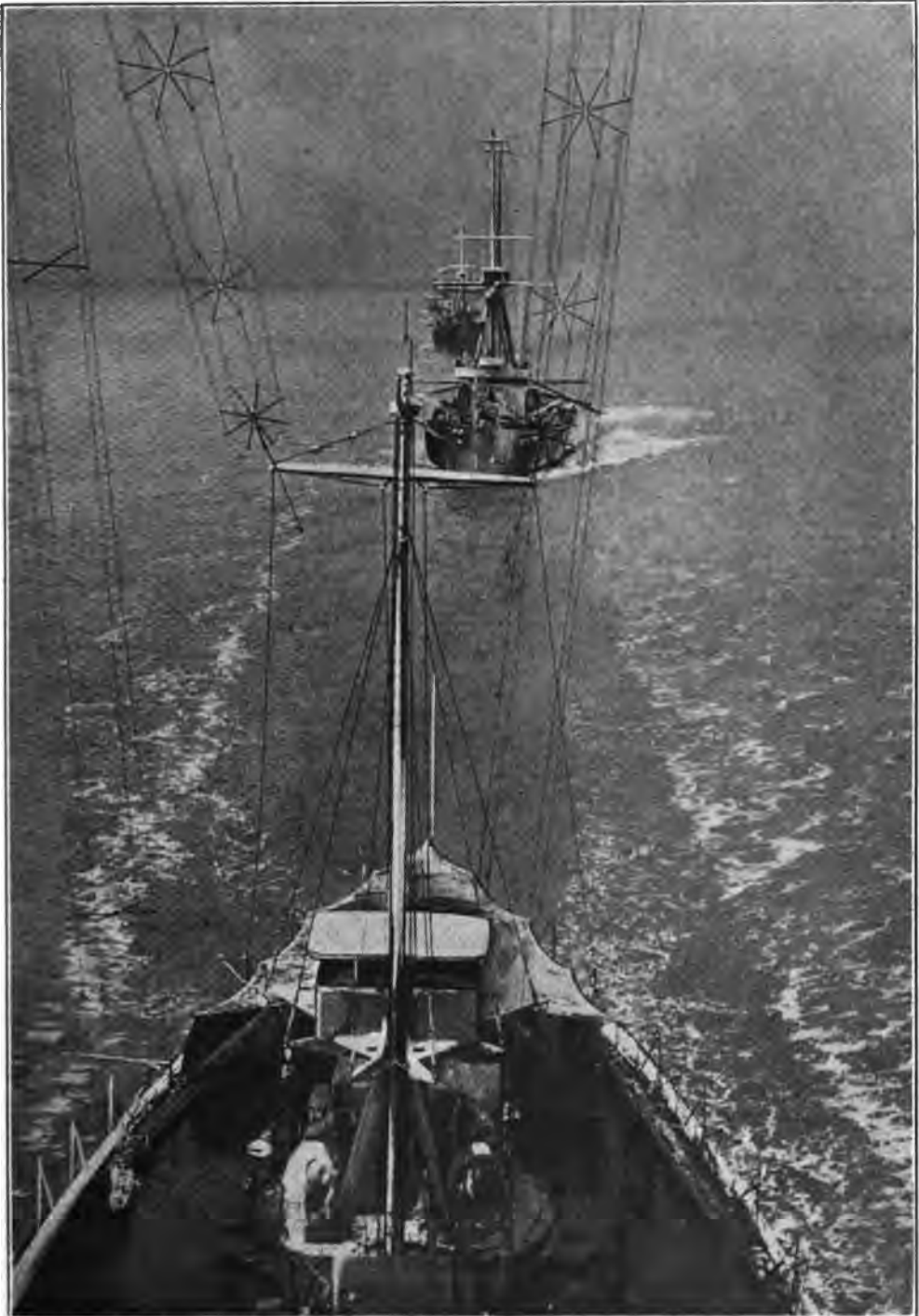

*Our illustration shows the adverse circumstances under which much of our naval work is conducted. The snow which can be seen at the back of the battle cruisers, and the general wintry character of the weather conditions, will bring home to our warm firesides some of the hardships encountered by "Jack afloat."*

# WIRELESS IN ACTION

## *Some Illustrated Notes.*

CONDITIONS still prevail which naturally prohibit any detailed reference to the part being played by wireless in the cause of the Allies. It is a certain fact, however, that many of the most thrilling incidents in this the world's greatest melodrama have had their origin or success determined by a wireless whisper.

It may be safely stated that at the outbreak of war the development of the military side of wireless telegraphy had far surpassed anything that might be classed as common knowledge. Commander C. F. Loring, R.N., Inspector of Wireless Telegraphy to the Post Office, writing on Wireless Telegraphy in the Navy in the *Naval Annual* of 1914, concluded his record of naval progress with an outline of the improvements introduced in 1909. "Subsequent to 1909," he says, "I am unable to point to any notable improvements or radical changes of general interest, as all later developments are still considered as confidential. Some idea, however, of the increasing importance attached by the Admiralty to this means of communication may be gathered from the fact that on board the *Vernon* alone there are now about twenty officers whose duties are appropriated solely to wireless telegraphy as compared with the three or four who were employed in the school in 1904, whilst the number of trained operators in the Fleet in 1912 stood at over 1,100. Similarly it is of interest to note that at the end of the year 1900 there were forty-two ships and eight shore stations equipped with wireless telegraphy in the Navy, and at the end of the year 1913 these figures have increased to 435 and thirty respectively."

The use of wireless on submarines was pretty general before the war broke out, no difficulty being experienced by these craft in maintaining communication between their parent ships or shore stations when quite a distance away. This intercommunication naturally ceased when the submarine dived and her antennæ were wholly or partly submerged.

### WATERSPOUT AERIALS.

One of the problems therefore connected with the use of wireless on these craft has been the rapid re-establishment of wireless communication after a dive. How far this has been solved we are not permitted to say, but reports in the foreign technical Press suggest that useful results have been obtained elsewhere by the aid of jets of salt water pumped vertically into the air. These novel antennæ are insulated from the sea by passing through a spiral tubing forming the coupling coil. Needless to say the waves set up on such aerials must be considerably damped and must have a limited radius of utility.

Two recent numbers of *THE WIRELESS WORLD*—the issues for November, 1914, and January, 1915, respectively—have contained details relating to wireless in military aviation. The former contained some general remarks upon the range of airships, and the latter specific statistics regarding the equipment in 1913 of the old Zeppelin *Viktoria Luise* and the purpose of the ring of wireless stations built at frequent intervals around the German frontier. Naturally the Germans, like ourselves, have kept all recent progress in military wireless strictly secret, but we are able this month to supplement our previous notes by a very interesting illustration. This is an authentic photograph taken in one of the great German aerodromes, showing in some detail the arrangements of the aerials on a Parseval airship. Although little has been written in the English Press about the German Parseval airships, possibly because they lack the magnitude of the Zeppelin and therefore do not make so great an appeal to the imagination, it is the Parseval and not the Zeppelin type of ship that has found the greatest favour amongst our aeronautical experts of this country. The recent "Warning" notices which have been freely displayed throughout the country show that we possess a Parseval very similar in general outline to the German prototype.

**WOULD YOU LIKE TO SPEAK  
FRENCH, GERMAN, or  
SPANISH?**

THIS IS VERY EASY IF YOU TAKE  
**HUGO'S** 1915 SELF-TUITION  
COURSE BY POST.

2/6 MONTHLY FOR ONE YEAR

Is not an expensive way of acquiring a Foreign Language.  
For this 30/- (10 % discount for cash) you at present get

1. Fifty Self-Tuition Lessons, sent post free, to any address in the world, in weekly Booklets.
2. A collection of Practice Tables; and
3. A Set of Hugo's unequalled Text-Books\*; and
4. Six Special Lessons, ORALLY or BY POST.\*

\* The total value of these extra Books and Lessons is upwards of 15s. Particulars on application.

This COURSE is THE ONLY ONE suitable for Students learning by themselves, as the pronunciation of Every Word is exactly imitated. No learning by heart required.

**HUGO'S COPYRIGHT PRACTICE TABLES and BOOKLETS** enable Students to begin to SPEAK and WRITE FRENCH, GERMAN or SPANISH in simple language from the very first lesson.

Write for full prospectus. Specimen Lesson free to all mentioning "The Wireless World" when inquiring.

**HUGO'S LANGUAGE INSTITUTE**

(Established 1875).

Address for Self-Tuition Enquiries:

33 GRACECHURCH STREET, LONDON, E.C.  
Teaching Branches for Classes or Private Lessons:  
33 Gracechurch Street, E.C. 64 and 66 Oxford Street, W. 205 Earl's Court Road, S.W.

**ATLANTIC COLLEGE**  
of Wireless and  
**Submarine Telegraphy**  
**CAHIRCIVEEN, CO. KERRY.**

A COMPLETE Wireless Installation specially erected by the Marconi International Marine Company for Tuition purposes.

The only College of its kind in the United Kingdom fitted with complete self-contained Electric Plant.

Youths trained for all examinations in Wireless and Submarine Telegraphy.

At the P.M.G. Examination held in College on 26th and 27th June, 1914, 30 out of 31 students examined were successful.

Write for Prospectus.

Readers of *The Wireless World* interested in all matters relating to Telegraphy should read  
**THE ELECTRICIAN**, A Weekly Journal, Price 6d., wherein appear everything of interest on these subjects  
**THE PRACTICAL WIRELESS SLIDE RULE.** By Dr. H. R. BELCHER HICKMAN. 2s. 6d. net, post free 2s. 9d. An indispensable companion to all who have calculations to make in Radio-Telegraphy.  
**HINTS ON WIRELESS TELEGRAPH DESIGNS FOR AMATEURS.** By ALFREG. New and Enlarged Edition. Very fully illustrated. Cloth, 2/6 net, post free, 2/9.  
**INTERNATIONAL RADIO-TELEGRAPH CONVENTION AND SERVICE REGULATIONS (London Revision, 1913)** in the Original French Text and Technically-accurate English Translation. Cloth 5/- net, post free 5/6.  
**ELECTRICAL TESTING FOR TELEGRAPH ENGINEERS.** By J. Elton Young. New edition. 10/6 net, post 11/-  
Of all Booksellers, or of THE ELECTRICIAN PRINTING & PUBLISHING Co., SALISBURY COURT, FLEET ST., LONDON, ENGLA

**Manual of Wireless Telegraphy**  
**FOR THE USE OF NAVAL ELECTRICIANS**

By **COMMANDER S. S. ROBISON, U.S. Navy**

An Excellent Textbook for  
Marconi Students. Recommended by the leading  
teachers. Cloth 8vo. New Ed  
241 pp. Illustrated 8s. 6d. 1  
or 8s. 10d. Post free 11s  
**S. RENTELL & CO., L.**  
36 Maiden Lane, Strand  
LONDON.

**The Post Office Electrical Engineers' Journal**

The January, 1915, issue, contains:—

Published Quarterly

- Improvements in Long Distance Telephony. PROF. FLEMING, D.Sc.
- A New Private Branch Exchange System.
- Telegraph Repeaters. MAJOR A. C. BOOTH.
- The Traffic Side of Telephone Exchange Design Work. H. F. E. DEANE, A.M.I.E.E.
- Balancing of Underground Telephone Cables. S. A. POLLOCK, M.I.E.E
- The Ethics of Supervision. A. S. RENSHAW.
- The Press Bureau.
- Bag Cleaning Machines. E. H. WALTERS.
- Notes, Book Reviews, Staff Changes, Etc., Etc.

Publishers ... .. H. ALABASTER, GATEHOUSE & CO., 4 Ludgate Hill, E.C.

Price 1s. net, post free, 1s. 3d.

Annual Subscription, postage inclusive, 5s.

Please mention "The Wireless World" when writing to Advertisers.

## THERE'S A REASON

When Commendatore Marconi accomplished his first Transatlantic message, the most sceptical person was then convinced that Wireless was not only possible, but an undoubted good thing to place one's money into. *(THEY ARE NOW SHAREHOLDERS.)*

Now, that's the same with tuition when we say and prove that our system of instruction is good; that our Colleges are fitted with the latest Marconi plant, and that our fees are the lowest in Great Britain; and conclude by saying that we have dealt with more than three hundred men during 1914-15. *(THEY ARE NOW OPERATORS.)*

You will feel encouraged to write for particulars of Day, Evening, and Postal Classes. The Secretary will answer your application personally.

**THE NORTH BRITISH WIRELESS SCHOOLS LIMITED**  
Edinburgh: 8 North Bridge. Glasgow: 141 Bath St. Dundee; Melville House.

An Efficient and Reliable Accessory  
for Wireless and Signalling Plants.

# E.P.S. ACCUMULATORS

ELECTRICAL  
POWER STORAGE  
COMPANY L<sup>D</sup>.

MILLWALL  
LONDON  
Telephone East 3856

### WIRELESS AND CABLE TELEGRAPHY.

## The London Telegraph Training College, Ltd.

TELEPHONE:  
2600 WESTERN.

Morso House, Earl's Court, S.W.

ESTABLISHED  
21 YEARS.

OFFICES: 262 EARL'S COURT ROAD, S.W.

THE College not only provides the necessary training for the above Services, but, owing to its intimate connections with the principal Cable and Wireless Telegraph Companies, is in the unique position of being able to obtain for all students lucrative situations in either Service immediately they are qualified to accept them, at a commencing remuneration of from £100 to £200 per annum. It possesses **TWO WIRELESS TELEGRAPH STATIONS** fitted with the latest type of apparatus supplied by **MARCONI'S WIRELESS TELEGRAPH COMPANY, LTD.**, and has been recognised during the past eight years by the Company as a recruiting source for operators desirous of entering its service. Since the outbreak of War all the Wireless Apparatus in the Cabin and Lecture Room vital to instruction has remained intact by **special permission of the Government**, who have also authorised the College to continue the instruction as heretofore in this branch of Telegraphy.

A number of Operators have been supplied since the War commenced both to the Army (R.E.) and Navy (R.N.R.).

### DAY AND EVENING CLASSES.

Arrangements have recently been made whereby special facilities are now available for obtaining practical instruction at a small cost, for Officers in H.M. Forces desirous of becoming acquainted with Wireless and Field Signalling Apparatus; also for giving Morse Sounder and Buzzer practice either during the day time or evening to those wishing to learn or to improve their knowledge of the Morse Code. An important feature of these arrangements is a new short course of instruction in the **Marconi System** at a reduced fee.

Government Examinations for the Postmaster-General's Certificate in Wireless Telegraphy are held at frequent intervals at the College.

*An Illustrated Prospectus containing full information of the various Courses, together with Tuition Fees, List of Appointments and recent Testimonials, will be forwarded on application to*

THE SECRETARY (Dept. H), 262 Earl's Court Road, Earl's Court, London, S.W.



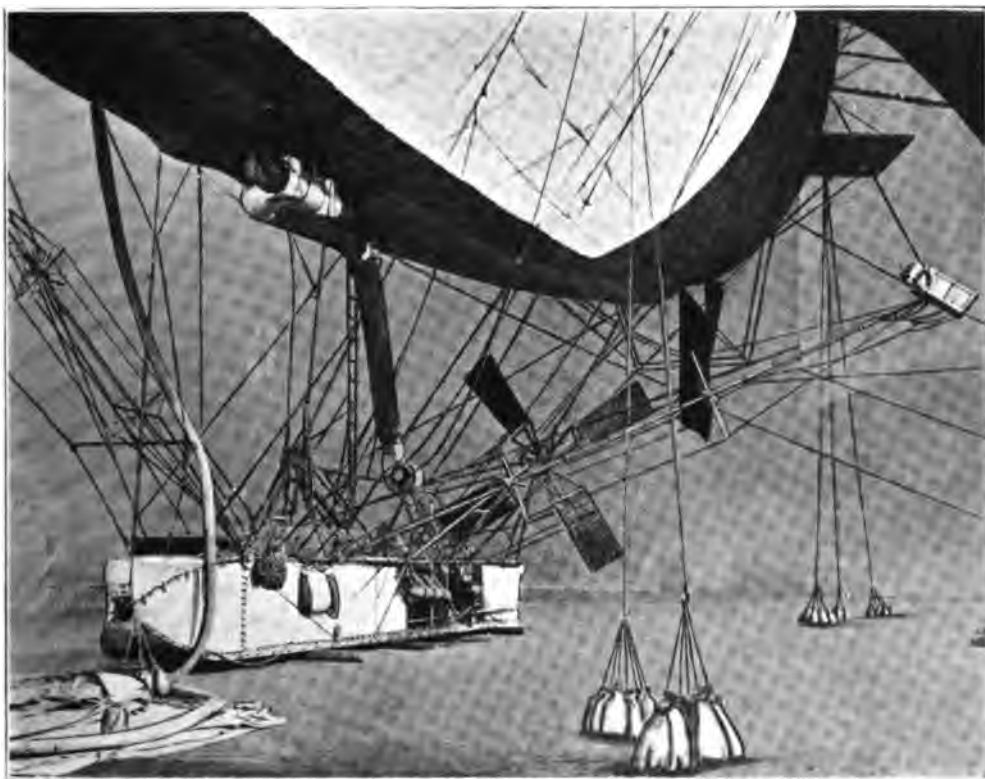

*Car and Wireless Equipment of a Parseval Airship*

The Parseval airship, it may be explained, is one of the non-rigid class. Unlike the Zeppelin, it does not rely for its lifting power upon a series of balloonets arranged within a stiff metal framework, but maintains its dirigibility by means of the gas pressure upon the envelope. The car, which is relatively small, is suspended below the gas bag. The great advantage to be gained from this type of airship is the ease with which it may be deflated and transported to an operating base, to perform, if needs be, a continuance throughout the night of the work conducted by aeroplanes during daylight. The Parseval type of non-rigid airship has a propeller built up of fabric, a method of construction found to be particularly suitable for war-craft.

Unlike the Zeppelin the German Parseval appears to dispense with the trailing aerial and rely instead upon star-shaped antennæ stretched out at right angles to the car on bamboo or composite poles. These can be raised and lowered at will, and although they may not give the Parseval as great a range of

intercommunication as the Zeppelin they do permit of one important feature, the ability to cruise at night at relatively low altitudes. The Germans discovered quite early in their research that an airship cruising low down with the general haze and cloud forming a background is safer from observation, on average nights, than one flying high up.

The application of wireless to airships gave more instant success from a military point of view than the similar application to aeroplanes. Apart from the greater range afforded by the airship equipment, there was (at any rate for a considerable period) this great advantage. An airship by stopping its engines allowed the receipt of messages from the land stations. If an aeroplane stopped its engine it came hurriedly to earth. The aeroplane, therefore, before the advent of the sound-proof helmet was restricted to the despatch of signals.

Details of a typical French wireless equipment for aeroplanes appeared in a recent article in *Flight*. These equipments

are apparently made in two sizes, one weighing 35 kilogrammes giving an effective daylight range of 100 kilometres, and another weighing 48 kilogrammes giving an effective radius of 200 kilometres.

The generator for the smaller set consists of a Bethenod magneto alternator having an output of 350 watts, low tension, and giving a spark frequency of 800 sparks per second. This alternator has no commutator.

The aerial employed in connection with this plant consists of a bronze cable about 1 mm. in diameter, ballasted at its extremity by means of a weight in the form of a spindle. This aerial trails in the air and assumes almost an horizontal position when the machine is in full flight. By means of brush contacts on the spindle of the winding reel the cable can be wound or unwound without interrupting the operation of the apparatus. An alternation in wave-lengths can thereby be easily effected. The "earth" connection in this case is replaced by an electrical capacity, all the metallic parts of the machine being connected together electrically.

The generator for the larger set, which alone weighs 19 kilogrammes, has a normal output of 750 watts, and like its smaller fellow is driven from the aeroplane engine. The musical note which is obtainable with

this generator can be varied from a low octave sound to a shrill whistle.

The oscillating circuits are arranged to give a wave-length of 400 metres. They consist of a condenser having a capacity of 100th microfarad and a spark gap. This gap in the smaller set is of the point and plate type, but in the larger set of a tube and a plate fitted with a ventilating apparatus.

For use upon seaplanes, where messages have to be sent whilst the machine is resting on the water, and the propelling machinery motionless, important alterations are made in the equipment. In the first place the trailing aerial is supplemented by one capable of being attached to a folding box kite. In the second place the generators are driven by independent petrol motors, one of 1 B.H.P. in the case of the smaller set, and of 3 B.H.P. for the larger set. Where an auxiliary motor cannot be used accumulators are carried, giving an output of 50 watts and a transmitting radius of 80 kilometres in the daytime.

The receiving sets for use with the above are stated to be fitted with crystal and electrolytic detectors and very sensitive, loud-speaking telephones. The 'phones can be conveniently fixed to the aviator's helmets and so render possible the reception of signals when the engine is running.



*Wireless Fittings on a French Breguet Machine.*

## COMPANY NOTICES

**T**HE report of the Marconi Wireless Telegraph Company of Canada for the year ended January 31st, 1914, states that the business done under contract with the Canadian and Newfoundland Governments has satisfactorily expanded, but the ship traffic receipts were seriously interfered with through the destruction of the operating house at the Cape Race Station by fire. In the circumstances the increase in gross profit from \$60 to \$7,200 is a very creditable performance. Interest charges amount to \$24,500, as against \$19,000, and the net deficit is therefore \$17,300, as compared with \$18,900. In 1912-13 the loss was written off organisation expenses account, leaving only \$2,000 at the credit of that fund, which now serves to reduce the present deficit to \$15,300, the latter amount going forward for subsequent liquidation.

\* \* \*

The text of the report referred to above reads as follows :

"The report of the Marconi Wireless Telegraph Company of Canada, Ltd., for the year ended January 31st, 1914, states that the contract with the Canadian Government for the operation of the coast station on the Great Lakes has now been completed by the addition of new stations at Port Burwell, Toronto and Kingston. The operation of these stations has now been placed on a satisfactory basis, and this section of the company's business should henceforth produce a steadily increasing revenue. The company was also successful in securing the contract for the construction of these stations. Under agreement with the Newfoundland and Canadian Governments the company now operates the following stations: 10 small stations in Newfoundland and Labrador, 22 stations on the eastern coast of Canada, 8 stations on the Great Lakes of Canada. The Newfoundland stations are subsidised to the amount of \$4,630 per annum, and the Canadian stations \$89,200 per annum. According to the latest Government return covering steamships of Canadian register, there were 93 vessels at date equipped with wireless telegraphy, of which no less than 90 vessels are equipped with the Marconi system. The policy of systematically improving the contract for steamship

operation is being successfully carried out. With the completion of the duplex system the Louisburg Transatlantic receiving station has been brought into operation, in addition to the installation for high speed transmissions at Glace Bay. To provide for additional traffic with these improved facilities a special business campaign was inaugurated, which has so far yielded gratifying results, and which should materially improve the future Transatlantic traffic. This policy will be continued until the full capacity of the circuit is reached. As a result of the destruction of the operating house by fire on May 5th the Cape Race station suffered severely during the year. Prompt measures were taken to re-establish a temporary station, which was in operation within two days, but owing to the isolation of Cape Race it was not until September 30th that a full commercial service could be resumed. Improved equipment has now been installed, adding to the capacity of the station. The necessity for increasing the height of the masts has been strongly urged on the Government, and action has subsequently been taken for such construction, which will be completed before the end of the current year. Thus equipped, Cape Race will be the most important coast station on the North Atlantic Ocean, and the increase in earnings that can be expected is indicated by the results already apparent since the installation of the improved plant. Owing to this unfortunate occurrence the ship traffic receipts show only a small increase over the previous year. Transatlantic traffic shows improved receipts for the year, and the revenue from the operation of the Marconi system on steamers and sales of apparatus shows decided progress. Important legislation covering equipment of Canadian steamers with wireless telegraphy has been enacted during the year. This law became operative on January 1st, 1914, and since the close of the past fiscal year a number of contracts have been made with shipowners covering vessels affected by the Act. Work on the contract with the Department of Railways and Canals for the construction of stations at Le Pas and Port Nelson has been pushed forward and will be completed during the current year. Owing to exceptional difficulties encountered by

the Government through lack of terminal and transportation facilities, the company was unavoidably delayed in completing its portion of the work, but will not thereby be subjected to any financial loss. Owing to the isolation of the localities these difficulties had been anticipated. Communication between the two stations was established in February, which was a source of gratification to the Government."

### Personal.

In the "Wireless Telegraphy in the War," of our March number, on page 791, we had the pleasure of giving an extract from a letter written by Mr. Charles E. Gould, wireless operator on H.M.S. *Good Hope*. We below reproduce his photograph, by the courtesy and kind permission of his father, Mr. Thomas Gould, of Sonning-on-Thames, Berkshire.

Mr. H. T. Clarke, a Marconi operator, writing from the usual address of "Somewhere in France," says:—"I am going on quite well and keeping very fit at present. I have been in France with my regiment since last September and have been right up in the firing line ever since, so I consider myself very lucky so far. We are now working seven days in the trenches and seven days out; when we are out of the trenches we go about three miles from the firing line to billets in a large town here (I am unable to give you names of places or my address), and usually get a hot bath and a general clean up all round. It seems very strange, but one night we are about 300 yards from the German trenches and the next night having a walk around the town and enter a restaurant and call for a cup of coffee as if



Mr. W. MacKilligan.

nothing was on at all. I may say that the majority of the inhabitants are still in this town, and they are occasionally shelled by the heavy guns of the Germans, but all the notice that they take is to shrug their shoulders and say 'Allemande.' The weather is brightening up considerably here now, as it has been awful throughout the winter, especially in the trenches, sometimes over knee-deep in mud and water. There is one consolation that when we have been in a fix that way the Germans have been the same, and probably worse. We are now out for a rest, and go back into the trenches Sunday evening next. The reason for going in at dark is because the German trenches are only 400 yards from us, and they (the Germans) would make it jolly hot for us if they got to know that we were relieving. Hope the weather will keep getting finer, and then most probably we shall be able to do something more definite. Could write you a lot more, but the Censor would no doubt blue pencil it; so will close, hoping to be with the Company again very soon.

In connection with the sinking of the Royal Mail Steam Packet's steamer *Potaro* by the *Kronprinz Wilhelm* in the South Atlantic, and whose crew was landed at Buenos Aires, we are informed that the wireless operator of the former was Mr. William MacKilligan, of Aberdeen, whose photograph we reproduce above.

Jack Durrell Green, aged 16 years, son of Mr. James Green, of Wivenhoe, has been successful in winning the first prize in a Marconi wireless examination, which takes place annually in the Navy. Green is now serving on H.M.S. *Agamemnon*.

### A Sad Loss.

The following announcement appears in one of our American contemporaries:—

"Archie Thomas, aged twenty-one years, wireless operator at the leper colony at Penikese Island, Buzzard's Bay, Mass., and himself a leper, died of pneumonia recently. The colony is thus deprived of an important means of communication with the outside world."

There is a world of tragedy contained in the brief announcement reprinted above.



Mr. Charles E. Gould.

## WIRELESS TIME SIGNALS.

### Practical Notes on their use at Sydney, N.S.W

**W**E have been favoured with the following article from Mr. F. Basil Cooke, F.R.A.S., of the Observatory at Sydney, New South Wales. The communication was inspired by the article in *THE WIRELESS WORLD* for November, 1914, on "Wireless Time Signals," and may be read in connection therewith. It indicates the practical use of wireless made at the Sydney Observatory.

\* \* \*

I think it universally known that the Commonwealth has at last undertaken the completion of the trans-continental railway which will connect Perth through Adelaide to Melbourne, and then from Melbourne through Sydney to Brisbane. This will make a complete chain of railway linking all the five capitals.

The line is complete from Brisbane to Adelaide, but there is no rail from Adelaide to Perth, and it is this last link that is now in the making.

In this gigantic undertaking it is absolutely essential that certain places along the proposed track should be located with precision.

In fixing the position of a place it is essential that we have two factors—namely, latitude and longitude. The latitude can easily be determined by a theodolite by any skilled surveyor.

The determination of longitude, however, is an entirely different proposition, as it is a purely relative function of time. The longitude is directly determined by a comparison of the time at any given instant between the unknown place and some known place, preferably an observatory.

The usual method of procedure is as follows :

Let us denote the unknown place by X and the known observatory by Y. Firstly, some star is selected for observation, and the exact time taken by the clock at X when the star is exactly on the meridian. The same evening the exact time is taken

at Y when that star is on the meridian. Now it takes a certain time for the star to pass from the meridian at X to meridian at Y, and this difference of time is the difference in longitude between X and Y.

The most important part of the whole procedure is the comparison of clock X with clock Y. This has in the past been done by cable or land telegraphic line, which has, however, always introduced an unknown factor. The time of transmission and armature times have played an important part in this factor.

Once more wireless has shown us a way out of our difficulty, and has made it possible to eliminate the unknown error, and also made it possible to determine the longitude of places not already connected by metal circuits.

The method used is practically the same as that described in your article using the method of coincidences. The particular work we have just been interested in was the determination of Port Augusta, which is the survey base of the trans-continental railway.

With respect to the main difficulty mentioned in your article—*i.e.*, the hearing of the ticks from the controlling and controlled clocks—I should like to state that we have been fortunate enough to absolutely eliminate this very serious trouble in the following manner: around every pair of contacts we have shunted a wet condenser; the consequence is that there is absolutely no sparking at any of the contacts, and therefore there are no oscillating currents set up. I should like to add that all these shunts are home made and are absolutely effective. They act beneficially in two ways: firstly, they eliminate the wireless trouble; and, secondly, they save a great deal of trouble with the contacts. Whereas formerly we were constantly having to clean and true up our contacts, now we need scarcely ever touch them. These shunts, for the description of which I am indebted to the Eastern Extension Telegraphic Co., are of simple construction, and consist of two pieces of aluminium wire immersed in a 10 per cent. solution of ammonium sulphate, the whole being enclosed in a small gallipot and hermetically sealed.

Unfortunately, I am not able at present

to furnish any figures in connection with our recent work with Port Agusta, but I have reason to believe that the wireless results will turn out to be equally satisfactory with those obtained at the same time with the land line, although this is our first attempt at that kind of work. There seems to be no doubt that in the future all longitude determinations will be carried out by means of wireless; and, also, this method opens up a vast field of very important work to be done in the southern hemisphere—such, for example, as correctly charting the South Sea islands, etc.

As for hearing the ticks from our own clock, instead of using an induction coil and connecting the phones to the terminals of the secondary, we have inductively coupled the primary (carrying the current from the clock) to the secondary of the jigger. This seems to me to be more satisfactory, because in the former case the incoming ticks from the distant station have a very good chance of leaking across the secondary of the coil rather than all going through the phones; further, our own arrangement enables us to more easily cut our signals down to the same audibility as the incoming signals.

In conclusion, I should like to state that all our instruments were made at the observatory, and are capable of very fine work. In the work referred to we received the clock beats from Melbourne and Adelaide. In addition, we have heard Perth (2,200 miles across land), and have no difficulty in hearing Brisbane, Hobart, New Zealand, Numea, etc. The aerial is a four-strand T aerial 90 ft. high at one end and 70 ft. at the other. Its length is 90 ft.

### Trade Notes.

Perhaps one of the most important requisites of the Drawing Office, and also one of the most costly, is tracing cloth. The original tracing cloth was invented in 1859 by Mr. F. G. Spilsbury, and since that date improvements have been made until manufacturers were able to produce the material which for many years has been regarded as almost the perfected article. The price of the tracing cloth was, however, still high owing to the cost of production and the fact that the material was manufactured only by a very few firms, and consequently the market price could be controlled in favour of the producers.

Just recently it has been brought to our notice that an English competitor has come forward who has produced tracing cloths equal in every respect

to those manufactured by other English houses and infinitely superior to any foreign production. Moreover, the new cloth has several distinct advantages over other makes. We would particularly emphasise the fact that the new tracing cloths are specially prepared for use without chalk. In addition to embodying to a high degree of perfection all the essential features of first-grade articles, the new material is sold at a figure about 10 per cent. below other cloths of similar quality.

This new tracing cloth, which is manufactured under the brand of "R.C.," may be obtained from B. J. Hall & Co., Ltd., of Chalfont House, Westminster.

We have been asked to notify to friends of Messrs. Harvey's, the uniform tailors who supply so many of our gallant soldiers and sailors, that their address has been changed to 17, London Street, right opposite to Fenchurch Street Station.

**FINAL DIGEST FOR WIRELESS STUDENTS.**  
First Edition, 9d. Second Edition, 2/7½ post free. Complete Guide to Government Examination. *Journal of Commerce*: "There is much matter in the book which students will find it difficult to get elsewhere." Sole publisher: J. HENSTOCK, 5 Deeside Parade, West Kirby.

**THE YEAR BOOK OF WIRELESS TELEGRAPHY & TELEPHONY, 1915,** will be published this month. Price 3/6 net; post free in United Kingdom 4/-; Abroad 5/-.—THE WIRELESS PRESS, LTD., Marconi House, Strand, W.C.

**THE ELEMENTARY PRINCIPLES OF WIRELESS TELEGRAPHY,** by R. D. Baneray. Price 1/2 post free. A book eminently suitable for the beginner.—THE WIRELESS PRESS, LTD., Marconi House, Strand, W.C.

**HANDBOOK OF TECHNICAL INSTRUCTION FOR WIRELESS TELEGRAPHISTS,** by J. C. Hawkhead. Price 3/6. A complete Course for the P.M.G.'s Certificate.—THE WIRELESS PRESS, LTD., Marconi House, Strand, W.C.

**BINDING CASES** for Volume II. of **THE WIRELESS WORLD** are now ready. Price 1/3 post free.—THE WIRELESS PRESS, LTD., Marconi House, Strand, W.C.

**COPIES** of Volume II. of **THE WIRELESS WORLD**, cloth bound, bevelled boards, will be on sale 21st inst. Price 4/6 net. Postage for United Kingdom, 8d. Abroad at Foreign Parcel Post Rates. As only a limited number are in preparation, orders should be placed at once.—THE WIRELESS PRESS, LTD., Marconi House, Strand, W.C.

**SPECIME COPIES.**—We shall be pleased to send entirely free of charge a few specimen copies of **THE WIRELESS WORLD** to the friend of any reader likely to be interested in the magazine. Send a postcard to Sales Manager, **THE WIRELESS WORLD**, Marconi House, W.C.

**MORSE CODE CARD,** showing Alphabet, Numerals, Abbreviations, etc., at a glance. Price 2d. post free.—THE WIRELESS PRESS, LTD., Marconi House, Strand, W.C.

**ANY BOOKS** reviewed in the **WIRELESS WORLD** or other magazines, will be forwarded per return upon receipt of remittance covering cost of book and postage.—THE WIRELESS PRESS, LTD., Marconi House, Strand, W.C.

**MARCONI OPERATORS** and others studying Wireless Telegraphy will find our series of Test Cards and books of Model Answers of considerable assistance in attaining proficiency. Full particulars on page xliii of this issue.

**MAP OF THE WORLD,** showing principal Wireless Stations, revised March, 1915. Price 1/8 post free. THE WIRELESS PRESS, LTD., Marconi House, Strand, W.C.

**PARTNER WANTED,** prepared to invest £500 with a prosperous Wireless Training College Ltd. Co., purely for Extension purposes. This is a splendid opening for anyone who has a knowledge of Wireless. Principals or Solicitors only "who mean business" need apply; references exchanged.—Box 316, **WIRELESS WORLD**, Marconi House, Strand, London, W.C.